

Manual

Software L-LAS-TB-Scope V3.16

(PC software for Microsoft® Windows® Vista, XP, 2000)

for laser line sensors of the *L-LAS-TB* series

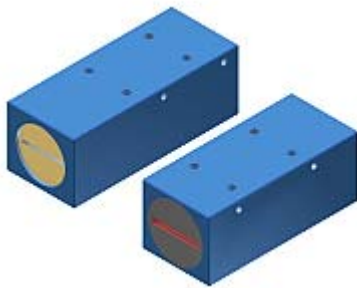

Split version, e.g.

L-LAS-TB-12
L-LAS-TB-25
L-LAS-TB-35
L-LAS-TB-55
L-LAS-TB-75
L-LAS-TB-100

L-LAS-TB-(16)-CL
L-LAS-TB-100-CL

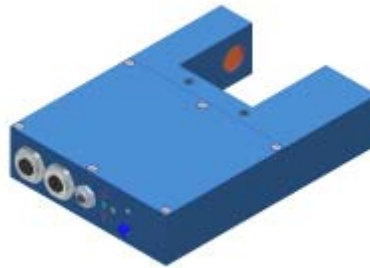

Fork-type version, e.g.

L-LAS-TB-F-(8)-40/40
L-LAS-TB-F-(8)-200/40
L-LAS-TB-F-(16)-40/40
L-LAS-TB-F-(16)-100/60

L-LAS-TB-F-(6)-40/40-CL
L-LAS-TB-F-(16)-100/100-CL



Split version with separate electronic control unit, e.g.

L-LAS-TB-6-CON1
L-LAS-TB-8-CON1
L-LAS-TB-12-CON1

0 Contents

Chapter	Page
1. Functional principle: <i>L-LAS-TB control unit</i>.....	3
1.1 Technical description.....	3
2. Installation of the <i>L-LAS-TB-Scope software</i>	4
3. Operation of the <i>L-LAS-TB-Scope software</i>	6
3.1 Control elements of the <i>L-LAS-TB-Scope software</i>	7
3.2 Numeric and graphic display elements	17
3.3 Serial RS232 data transfer	19
3.4 <i>L-LAS-TB-Scope</i> as an aid for sensor adjustment.....	21
3.5 <i>L-LAS-TB-Scope</i> as an aid for transmitter power adjustment.....	22
4. Evaluation modes.....	23
4.1 LEFT-EDGE	23
4.2 RIGHT-EDGE	24
4.3 WIDTH.....	24
4.4 CENTER.....	24
5. Function of data recorder	25
5.1 Format of output file.....	26
5.2 3 byte RS-232 data transfer	27
6. Two-point calibration	29
7. Annex.....	32
7.1 Laser warning	32
7.2 Function of the TEACH/RESET button	32
7.3 Function of the tolerance potentiometer.....	32
7.4 Function of digital inputs IN0 and IN1	33
7.5 Connector assignment	34
7.6 RS232 interface protocol.....	36

1 Functional principle: *L-LAS-TB control unit*

1.1 Technical description

In the laser line sensors of the *L-LAS series* the laser beam of a laser diode ($\lambda=670\text{nm}$, 1mW power, laser class 2) through suitable collimators and apertures is emitted from the optical transmitter unit as a laser line, i.e. as parallel laser light with homogeneous light distribution. In the optical receiver unit the laser line impinges on a CCD line receiver. This CCD line comprises many closely adjacent individual receiver elements (pixels) that are arranged in a line. The light quantity of each of these receiver elements that is collected during the integration time can be separately read out as an analog voltage and, after performing analog-digital conversion, can be stored in a data field as a digital value.

When there is a non-transparent measuring object in the laser line, the parallel laser light only illuminates those receiver elements (pixels) of the line that lie outside the shadow zone of the measuring object. As a result the pixels within the shadow zone give off a considerably lower analog voltage compared to the illuminated pixels. By way of suitable software algorithms the areas of the shadow zones can be determined from the previously stored data field. Since the distance of the pixels on the CCD line is known, the size and position of the measuring object can therefore be determined. The micro-controller of the *L-LAS-TB sensor* can be parameterized through the serial RS232 interface by means of a Windows PC software. The sensor can be set to operate with different evaluation modes. The housing of the control unit features a TEACH/RESET button [1] and a potentiometer for tolerance setting. Switching states are visualized by means of 4 LEDs (1x green, 1x yellow, and 2x red) that are integrated in the housing of the L-LAS-sensor. The *L-LAS-TB control unit* has three digital outputs [2] (OUT0, OUT1, OUT2), the output polarity of which can be set with the software. Two digital inputs (IN0, IN1) make it possible to realize an external TEACH/RESET functionality and an external TRIGGER functionality through a PLC. In addition the control unit features a high-speed analog output (0 ... 10V) with 12-bit digital/analog resolution.

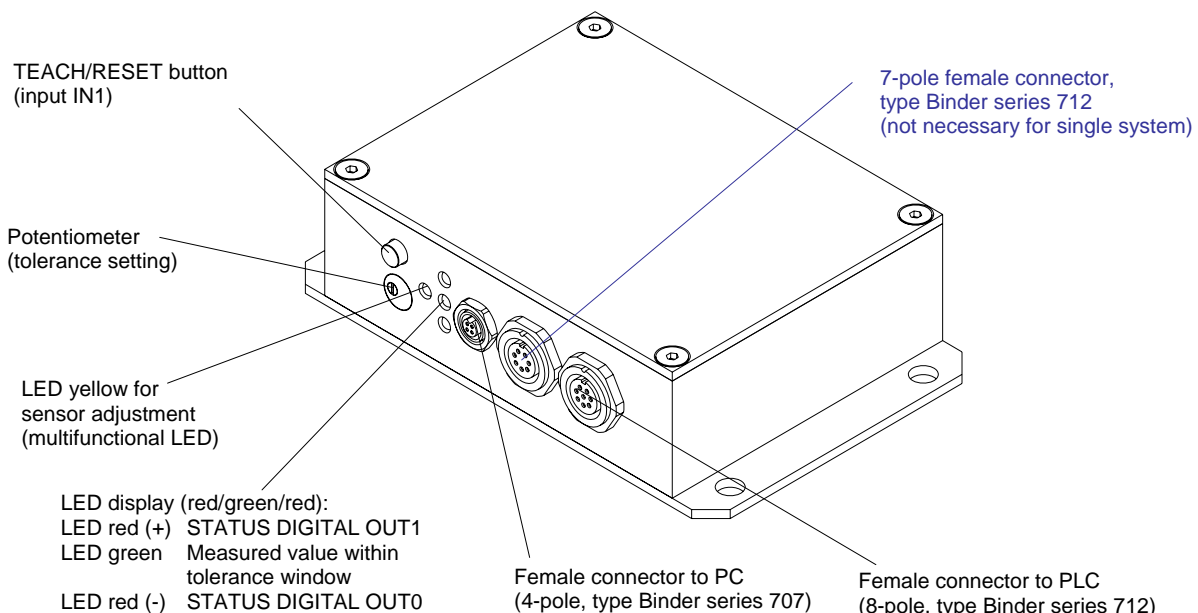

[1] not available in case of a model of CL series

[2] CL series offers only two digital outputs OUT0, OUT1

2 Installation of the *L-LAS-TB-Scope* software

Hardware requirements for successful installation of the *L-LAS-TB-Scope* software:

- 400 MHz Pentium-compatible processor or better.
- CD-ROM or DVD-ROM drive
- Approx. 10 MByte of free hard disk space
- SVGA graphics card with at least 800x600 pixel resolution and 256 colors or better.
- Windows 98, Windows NT4.0, Windows XP, or Windows Vista operating system
- Free serial RS232 interface or USB port with USB-RS/232 adaptor at the PC

Please install the *L-LAS-TB-Scope* software as described below:

1.  **CD-Laufwerk (D:)** Insert the installation CD-ROM in your CD-ROM drive. In our example we suppose that this is drive "D".

2.  **setup.exe** Start the Windows Explorer and in the folder tree of your CD-ROM drive go to the installation folder D:\Install\ . Then start the installation program by double-clicking on the SETUP.EXE symbol.

As an alternative, software installation can also be started by clicking on **START-Run...** and then entering "D:\Install\setup.exe", which must be confirmed by pressing the **OK** button.

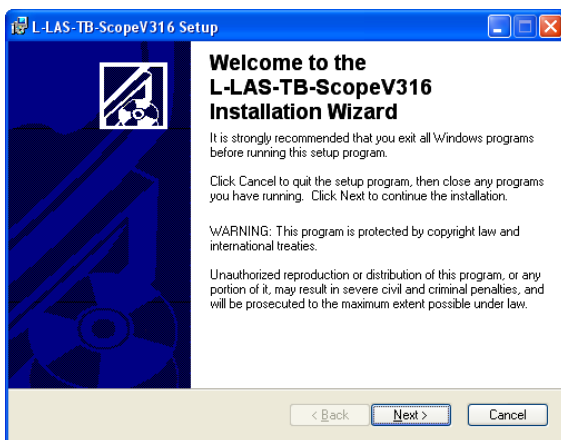

The installation program then displays a dialog box for *L-LAS-TB-Scope* installation. This dialog box shows some general information about installation.

Click on **Next>** to start the installation



or on **Cancel** to quit the installation of the *L-LAS-TB-Scope* software

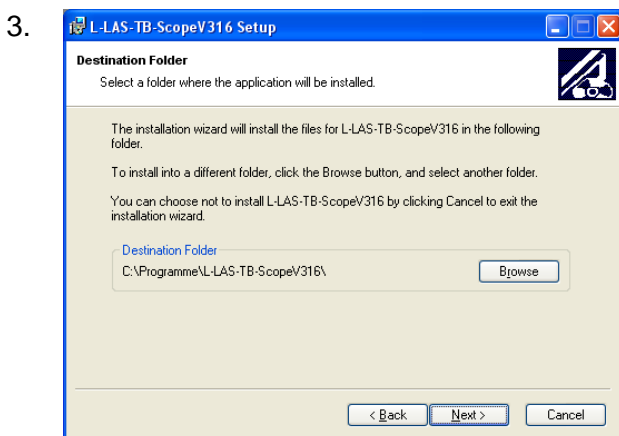
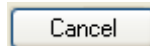

When you click on the **Next>** button, a new dialog appears for selecting the folder where the application will be installed (destination folder).

You may accept the suggested folder with **Next>**, or you may change the installation folder as desired by clicking on the **Browse** button.

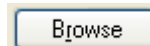

4.

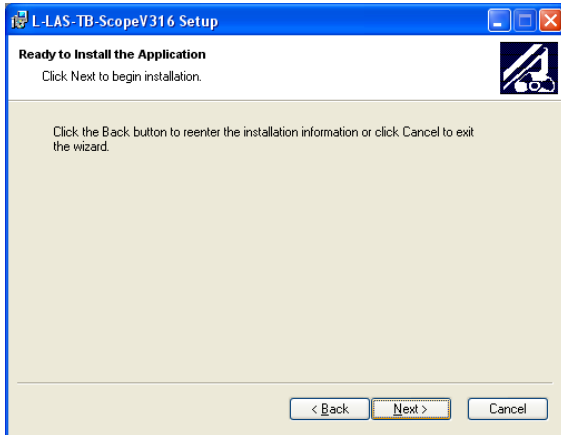

Another *L-LAS-TB-Scope* Setup dialog will be displayed.

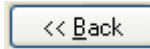

Click on the **Back** button if you want to change the installation folder again.



Click on **Next>>** to start the installation, or

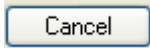

click on **Cancel** to quit the installation process.

5.

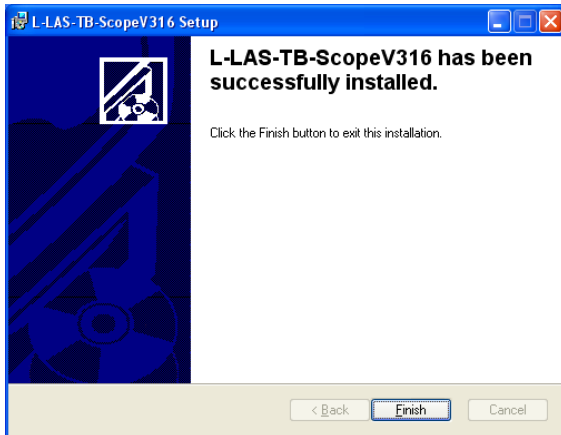

When installation is completed, a dialog box informs you about successful installation.

A new *L-LAS-TB-Scope* program group has been created under Start-All-Programs.



Click on the **Finish** button to finish the installation.

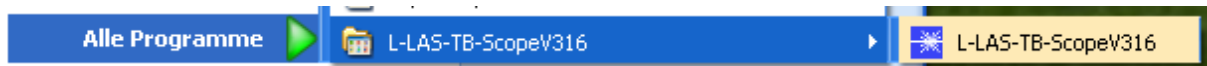

The *L-LAS-TB-Scope* software can now be started by clicking on the respective icon in the newly created program group under:
Start >All Programs > L-LAS-TB -ScopeV3.16

Deinstallation of the L-LAS-TB-Scope software:



Software

Please use the Windows deinstallation tool to remove the software.

The Windows deinstallation tool can be found under Start / Settings / Control Panel.

3 Operation of the *L-LAS-TB-Scope* software

The *L-LAS-TB-Scope* software is used for parameterizing the electronic control unit used for controlling the *L-LAS* line sensors. The measured values provided by the sensor can be visualized with the PC software, which means that the software among others can be used for adjustment purposes and for setting suitable tolerance limits for the inspection of the measuring object.

Data exchange between the PC user interface and the sensor system is effected through a standard RS232 interface. For this purpose the sensor is connected to the PC with the serial interface cable *cab-las-4/PC*. When parameterization is finished, the setting values can be permanently saved in an EEPROM memory of the *L-LAS-TB control unit*. The sensor system then continues to operate in "STAND-ALONE" mode without the PC.

When the *L-LAS-TB-Scope* software is started, the following Windows® user interface will be displayed:

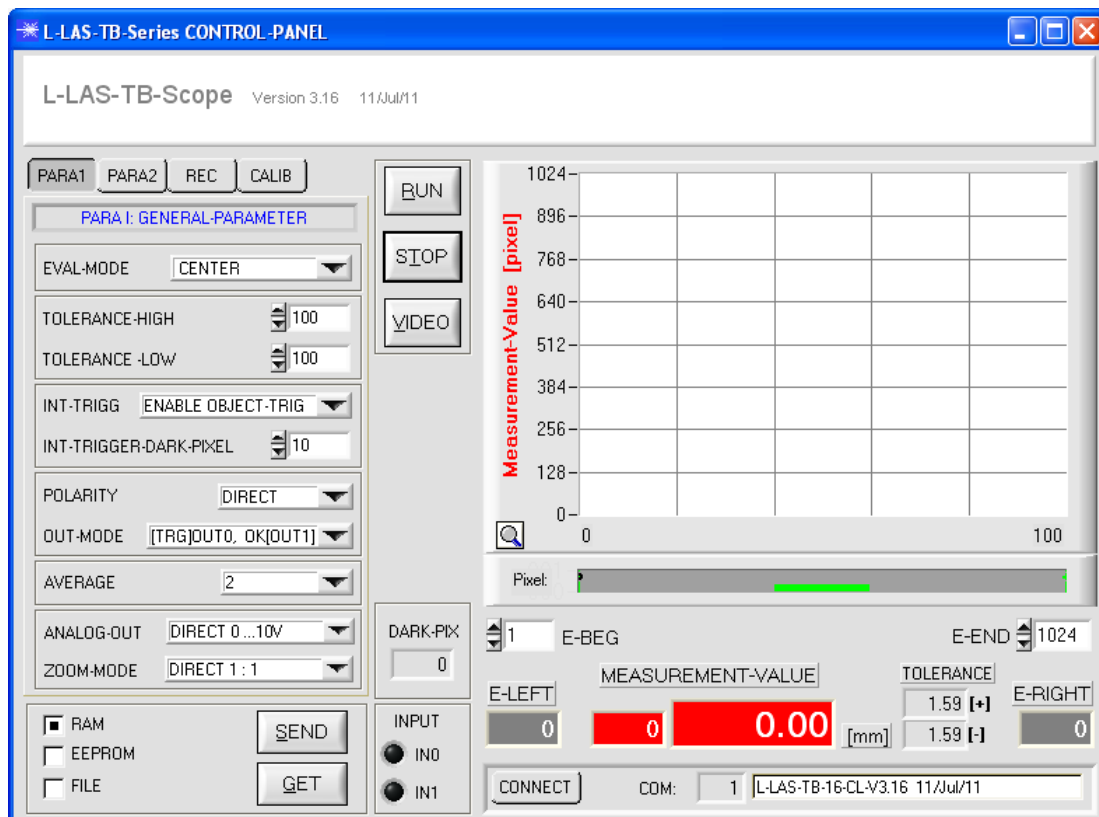

The *L-LAS-TB-Scope* CONTROL PANEL provides a great variety of functions:

- Visualization of measurement data in numeric and graphic output fields.
- Setting of the laser power for the laser transmitter.
- Setting of the polarity of the digital switching outputs OUT0, OUT1, and OUT2. [2]
- Selection of a suitable evaluation mode.
- Presetting of setpoint value and tolerance band.
- Saving of parameters to the RAM, EEPROM memory of the control unit, or to a configuration file on the hard disk of the PC.

The following chapters provide explanations of the individual control elements of the *L-LAS-TB-Scope* software.

[2] CL series offers only two digital outputs OUT0, OUT1

3.1 Control elements of the L-LAS-TB-Scope software:

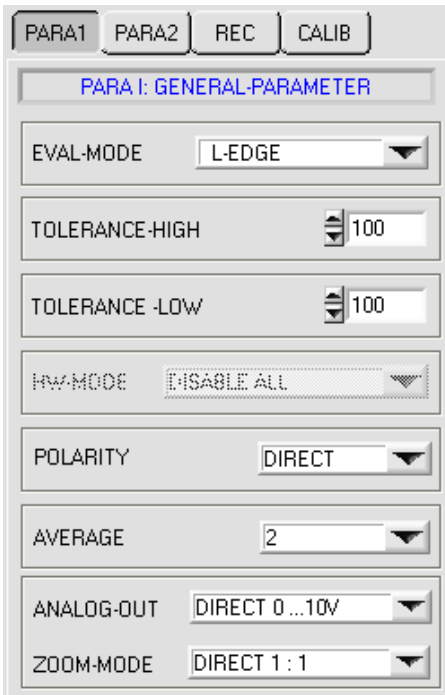

A click on the PARA1 button opens the PARAMETER I (PARA I) window, where various general parameters at the control unit can be set.



Attention !



Changes that are made in the function fields described below only become active at the control unit of the L-LAS-TB sensor after a click on the SEND button!

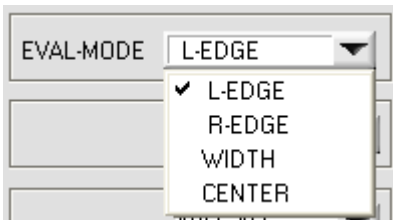

EVAL-MODE:

This list selection field serves for setting the evaluation mode at the L-LAS-TB sensor. Depending on the evaluation mode that is currently set, the edges created from the video signal (intensity profile) of the CCD line will be assessed differently.

L-EDGE:

The 1st edge (left edge) of the CCD line's intensity profile is used as measurement value.

R-EDGE:

The 2nd edge (right edge) of the CCD line's intensity profile is used as measurement value.

WIDTH:

The difference between the second and the first edge is used as measurement value: $WIDTH = R-EDGE - L-EDGE$

CENTER:

The mean value of the first edge and the second edge is used as measurement value: $CENTER = (L-EDGE + R-EDGE) / 2$

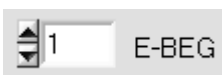

E-BEG:

Numeric input field for entering the beginning of evaluation. The CCD line is evaluated starting from the pixel that is set here (Evaluation-Begin). (Default value = 1).

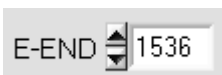

E-END:

Numeric input field for entering the end of evaluation. The CCD line is evaluated up to this pixel. Pixels on the right side of the pixel value that is set here will not be evaluated.

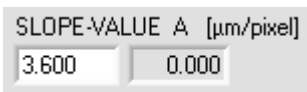
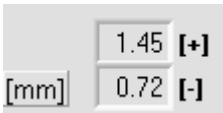
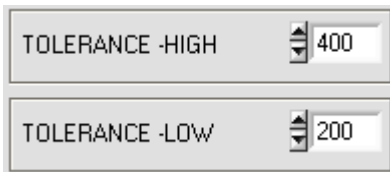

TOLERANCE-HIGH, -LOW:

In these input fields an upper and lower tolerance value for the tolerance window can be set by entering a numerical value or by clicking on the arrows. The tolerance window is applied symmetrically around the setpoint value (TEACH-VALUE) and is framed by the upper and lower tolerance threshold.

If the TOLERANCE potentiometer at the sensor housing is activated, the values for the upper and lower tolerances that are set at the potentiometer are displayed. The tolerance values that are currently set at the sensor are shown in a numerical display field below the graphic display area in [mm].

Example for the tolerances in combination with the SLOPE-VALUE (sensitivity):

$$TOL[+] [mm] = SLOPE * TOLERANCE_HIGH$$

Here: $TOL [mm] = 3.6[\mu m/Pixel] * 400 Pixel = 1.45 mm$

$$TOL[-] [mm] = SLOPE * TOLERANCE_LOW$$

Here: $TOL [mm] = 3.6[\mu m/Pixel] * 200 Pixel = 0.72 mm$

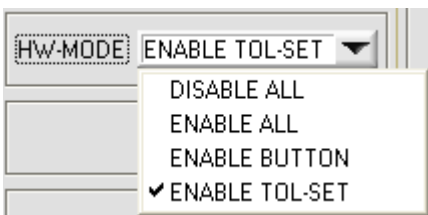

HARDWARE (Hardware-Mode) [1]:

The TOLERANCE potentiometer and the TEACH/RESET button at the housing of the L-LAS-TB sensor can be activated (ENABLE) or deactivated (DISABLE) by clicking on the respective item in the list selection field.

The TOLERANCE potentiometer allows the presetting of a tolerance window around the setpoint value. If the function field is set to ENABLE ALL or ENABLE TOL-SET, it is not possible to enter numerical values in the TOLERANCE-VALUE input field of the PC software. The respective function fields will be grayed.

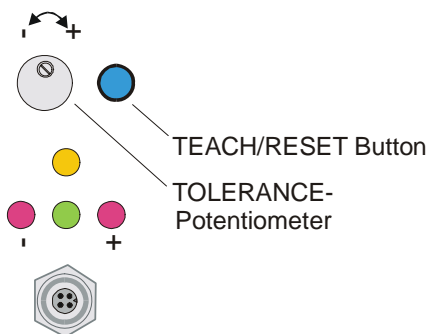

DISABLE ALL

Both the TEACH/RESET button and the TOLERANCE potentiometer at the housing are deactivated.

ENABLE ALL:

The TOLERANCE potentiometer at the housing is activated. (clockwise turning increases the tolerance bandwidth)
The TEACH/RESET button at the housing is activated.
Button pressed for a short time ($t < 0.7s$) : RESET function.
Button pressed for a long time ($t > 1.5s$) : TEACH function.

ENABLE BUTTON:

Only the TEACH/RESET button at the housing is activated.

ENABLE TOL-SET:

Only the TOLERANCE potentiometer at the housing is activated.

[1] not available in models of CL series

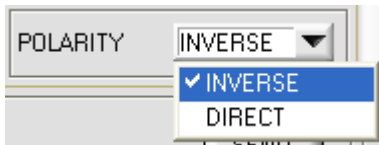

POLARITY:

In this function field the output polarity at the *L-LAS-TB sensor* can be set with a mouse-click. The *L-LAS-TB sensor* has 3 digital outputs (OUT0, OUT1, OUT2) through which error states can be sent to the PLC.

DIRECT:

In case of an error, the respective digital output is set to +Ub (+24VDC ± 10%, red LED on).

INVERSE:

In case of an error, the respective digital output is set to the reference potential (GND/0V, red LED on).

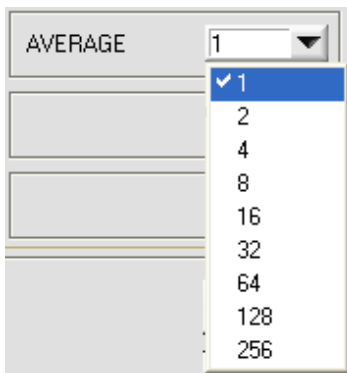

AVERAGE:

In this function field the averaging at the *L-LAS-TB sensor* can be selected with a mouse-click on the respective list item. With every cycle of the main program the current measurement value is stored in a ring memory field, and then the average of these values in the ring memory field is calculated.

The average of the ring memory field is used as the MEASUREMENT_VALUE. With the AVERAGE value the size of the ring memory can be set from 1 to 256.

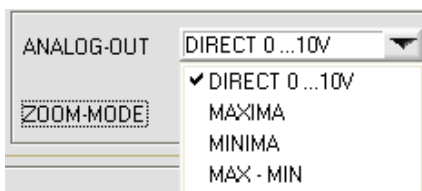

ANALOG-OUT (Analog-Output-Mode):

Function element for selecting the output mode of the analog voltage at the L-LAS sensor (pin8/red/ 8-pol. PLC/POWER female connector). The analog voltage is output in the range from 0 to 10V with a resolution of 12 bit.

DIRECT 0...10V:

A voltage (0 ... 10V) that is proportional to the current measurement value is provided at the analog output pin8/red.

MAXIMA:

The current maximum value is provided at the analog output pin8/red/ (drag pointer principle, resetting by input IN1/pin4/yellow pulse of <750ms length, or by pressing the TEACH/RESET button).

MINIMA:

The current minimum value is provided at the analog output pin8/red/ (drag pointer principle, resetting by input IN1/pin4/yellow pulse of <750ms length, or by pressing the TEACH/RESET button).

MAX-MIN:

The current difference between maximum and minimum value is provided at the analog output pin8/red/ (drag pointer principle, resetting by input IN1/pin4/yellow pulse of <750ms length, or by pressing the TEACH/RESET button).

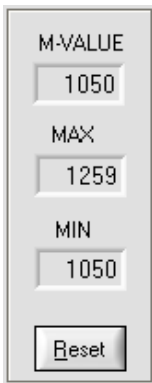

Reset button (Maximum-Minimum Values):

These display elements only appear after one of the three operating modes MAXIMA, MINIMA, or MAXMIN has been selected and activated in the ANALOG-OUT function field.

A click on the RESET button resets the current maximum and minimum values that are detected by the L-LAS sensor. The numeric display fields show the respective current maximum and minimum value.

Resetting of the maximum and minimum values also can be triggered by a short pulse (duration $t < 750$ ms) at digital input IN1/yellow/pin4 from the PLC. The maximum and minimum values also can be reset by pressing the hardware button at the housing of the L-LAS sensor.

Please note:

This RESET function does not perform a hardware/software reset at the *L-LAS* sensor, it only resets the maximum and minimum values!

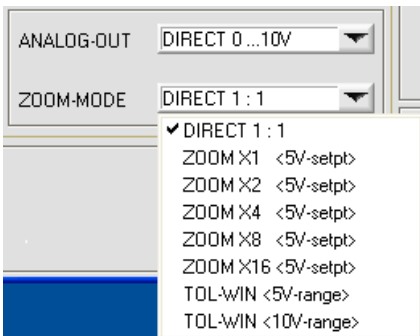

ZOOM-MODE (Analog-Output):

Function element for setting various zoom modes at the analog output of the *L-LAS-TB* sensor.

DIRECT 1:1:

At the analog output pin8/red/ the full measuring range of the sensor is provided as a 0 to +10V voltage swing.

ZOOM X1, ZOOM X2 ... ZOOM X16:

The difference between the current measurement value (pixels) and the teach position (teach value in pixels) is provided at the analog output pin8/red/. At the teach position a voltage of +5V is always provided at the analog output. If the current measurement value is lower than the teach position, a voltage $< 5V$ is output, if the current measurement value is higher than the teach value, a voltage $> 5V$ is output. The deviation from the 5V teach position can be amplified with a zoom factor of X2 to X16.

TOL-WIN <5V-range>:

A voltage swing of 5V over the current tolerance window is provided at the analog output pin8/red/. At the lower tolerance limit the voltage value is 2.5V, at the upper tolerance limit 7.5V. A voltage of 5V is provided at the teach position.

TOL-WIN <10V-range>:

A voltage swing of 10V over the current tolerance window is provided at the analog output pin8/red/. A voltage of 5V is provided at the teach position, at the lower tolerance limit the voltage at the analog output is 0V, at the upper tolerance limit 10V.

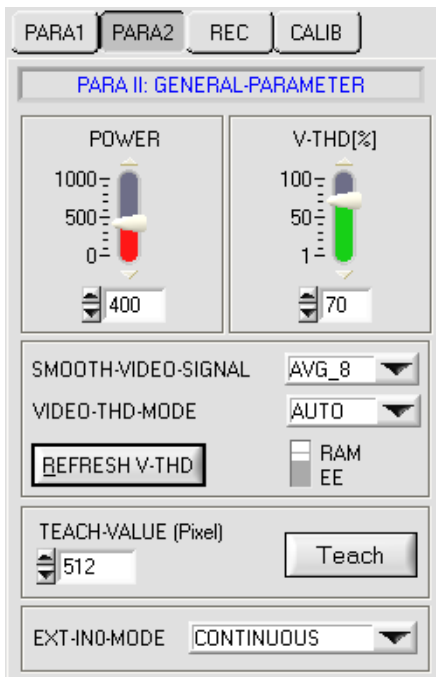

A click on the PARA2 button opens the PARAMETER II (PARA II) window, where additional parameters at the control unit can be set.



Changes that are made in the function fields described below only become active at the control unit of the *L-LAS-TB* sensor after a click on the SEND button!

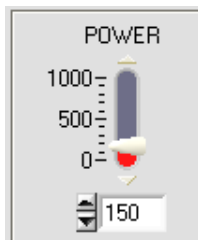

POWER:

In this function field the laser power at the laser transmitter unit of the *L-LAS-TB* sensor can be set by using the arrows or the slider, or by entering a numerical value in the respective input field.

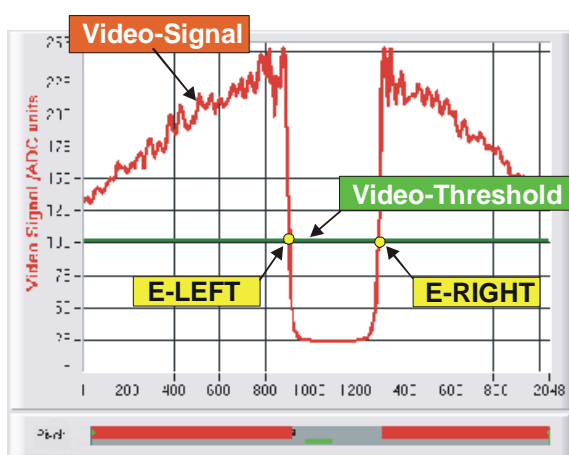
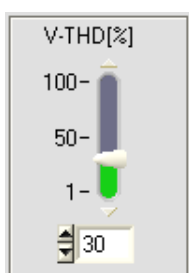

FIXED-VIDEO-THD[%]:

In this function field the video threshold at the *L-LAS-TB* sensor can be set by entering a numerical value or by using the slider or the arrows. With the help of this video threshold the measurement values can be derived from the intensity characteristic (video signal) of the CCD line from the bright/dark transitions. For this purpose the intersection points between the intensity profile (red curve) and the adjustable video threshold (green horizontal line) are calculated and stored.

The x-value of the respective intersection point is assigned to a pixel on the CCD line. The measurement value can be calculated from this information and from the known distances of the pixels on the CCD line. The intersection points between intensity profile and video threshold that are provided by this method are hereinafter referred to as edges.

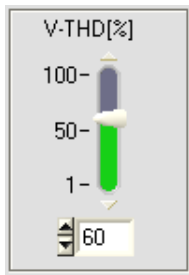

AUTO-Video threshold

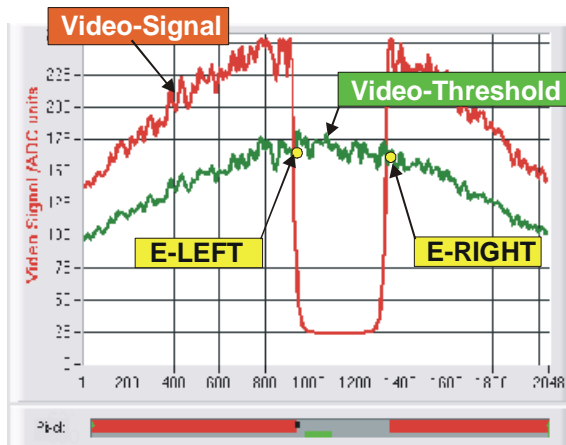

AUTO-VIDEO-THD[%]:

When the toggle switch is in AUTO position, the threshold that is stored in the non-volatile EEPROM of the sensor is used as video threshold.

This threshold (green curve) is not a horizontal line, but is derived from the intensity characteristic of the laser transmitter and thus "tracks" the intensity profile.

As before the measurement values are derived from the intensity characteristic of the CCD line (red curve) and the tracked video threshold (green curve). For this purpose the intersection points between intensity profile and tracked video threshold are calculated again.

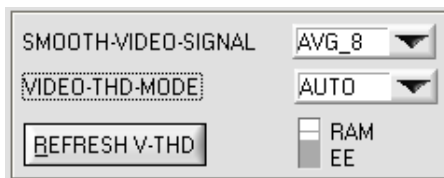

VIDEO-THD-MODE AUTO:

The automatic follow-up threshold mode is activated by selecting AUTO from the VIDEO-THD-MODE drop-down list field.

A click on the SEND button activates the selected mode at the sensor!

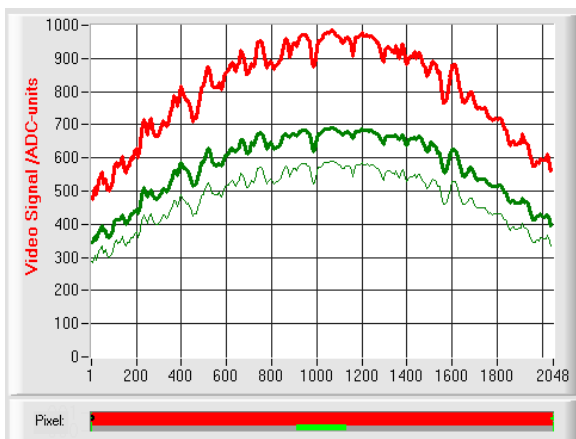

The current threshold can be changed by clicking on the arrow keys in the V-THD[%] slider.

The new video threshold first is shown as a thin green curve. This threshold (green curve) is not a horizontal line but is derived from the intensity characteristic of the laser transmitter (red curve) and thus "follows" the intensity profile. As before, the measurement values are derived from the intensity characteristic of the CCD line (red curve) and the follow-up video threshold (green curve) by calculating the intersection points between intensity profile and follow-up video threshold.



Attention !

Before the new video threshold is saved there must be no measurement object in the beam path between transmitter and receiver!

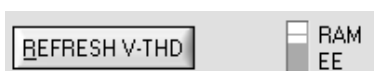

REFRESH V-THD:

Only a click on this software button saves the current intensity profile as a new video threshold to the non-volatile EEPROM of the L-LAS sensor.



GET:

After a click on this software button the video threshold that is currently saved in the EEPROM will be automatically shown in the graphic display window.

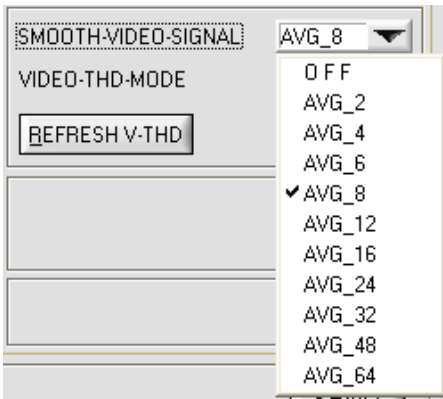

SMOOTH-VIDEO-SIGNAL:

A click on the SMOOTH-VIDEO-SIGNAL drop-down list field opens the setting options for the activation of a software filter for the video signal characteristic. If a software filter is activated, corresponding filtering of the video signal will be performed after every scan in the main program run.

With digital software filtering the video signal characteristic can be smoothed, if necessary

OFF:

The video signal is not filtered.

AVG 2:

The video signal is subjected to a 2nd-order moving average filter. Over the full video profile two adjacent values (pixels) each are used for averaging.

• • •

AVG 64:

The video signal is subjected to a 64th-order moving average filter. For this purpose 64 adjacent values (pixels) each are used for averaging.

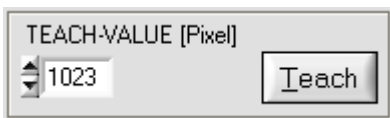

TEACH-VALUE [Pixel]:

Numeric input field for setting the current teach value (setpoint value) in pixels. The teach value that is set here only is activated at the *L-LAS-TB* sensor after a click on the SEND button.

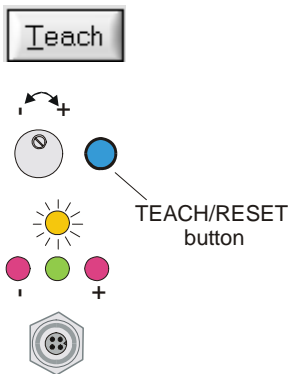

After a click on the TEACH button the current edge information is stored as a teach value to the RAM memory of the *L-LAS-TB* sensor. Depending on the evaluation mode that has been set (E-MODE), the left edge, the right edge, the width (WIDTH), or the center position (CENTER) will be stored as a teach value in the RAM memory of the L-LAS sensor.

When the teach process is completed, the yellow LED at the housing of the *L-LAS-TB* sensor quickly blinks 3 times.

The teach process also can be started by means of the TEACH/RESET button at the housing (pressing the button for $t > 1.5s$) or by way of a high level at digital input IN1/yellow/pin4 ($t > 1.5s$).



The newly taught setpoint value can be read out through the serial interface by clicking on the GET button.

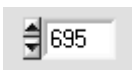

The new teach value is then shown in the TEACH display field.

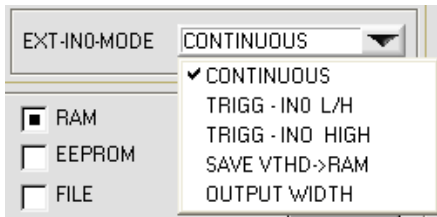

EXT-IN0-MODE:

This drop-down function field can be used to set the operating mode of the external trigger input (IN0/pin3/green, 8-pole PLC socket) at the *L-LAS-TB sensor*.

CONTINUOUS:

Continuous evaluation of current measurement values. No external trigger functionality.

TRIGG – IN0 L/H:

External edge-controlled triggering of measurement value evaluation through digital input IN0/pin3/green at the 8-pole PLC socket. The measurement value at the moment of the L/H edge is saved and applied at the digital outputs/analog output.

EXT. IN0 HIGH:

External triggering of measurement value evaluation through a high level (+Ub) at digital input IN0/pin3/green. Measurement value evaluation / analog output is enabled as long as digital input IN0 is at HIGH level (time window function).

SAVE VTHD ->RAM:

The external trigger input IN0 is used to save the current video threshold to the RAM memory of the *L-LAS-TB sensor* at the L/H edge. The "follow-up" video threshold is calculated as a percentage value from the current intensity profile over the CCD line. The parameter V-TDH[%] is used to calculate the new threshold.

OUTPUT WIDTH:

The external trigger input IN0 is used to switch the evaluation mode to WIDTH.

IN0 = HIGH -> EVAL-MODE = WIDTH

IN0 = LOW -> EVAL-MODE = LEFT, RIGHT or CENTER



Attention!

There must be no measurement object in the beam path between transmitter and receiver before the new video threshold is saved!

PARA1 PARA2 REC CALIB

DATA-RECORDER

RS-232-MODE:

TIME-INTERVAL [0.1 .. 3600] sec:

SAMPLES [MAX 32000]:

DAYS: HOURS: MIN: SEC:

START DATE: START TIME:

SAMPLE:

c:\Programme\RECORD.DAT

PARA1 PARA2 REC CALIB

A click on the REC button opens the DATA-RECORDER window on the user interface. Please also cf. chapter 5: Data recorder function.

RS-232-MODE:

RS-232-MODE:

Drop-down function field for setting the serial data request at the L-LAS-TB sensor.

STATIC (REC):

The sensor does not automatically send measurement data through the RS-232 interface. Every individual data transfer is started by the PC/PLC with command no. 18. Upon this request the sensor sends a single data frame (36 bytes) to the PC/PLC.

EXT-IN0 L/H (REC):

A single data frame (36 bytes) is sent to the PC/PLC at every LOW/HIGH edge at digital input IN0/pin3/green.

EXT-IN0 L/H (3-Byte): cf. chapter 5.2

CONTINUOUS (3-Byte): cf. chapter 5.2

TIME-INTERVAL [sec]

TIME-INTERVAL [sec]:

This numeric input field can be used to set a time interval in seconds (0.1s – 3600s). When this time interval is over, the PC software automatically requests measurement data from the sensor.

SAMPLES [MAX 32000]

SAMPLES [MAX 32000]:

Numeric input field for presetting the maximum number of measurement values that should be saved. The value range is 10 to 32000.

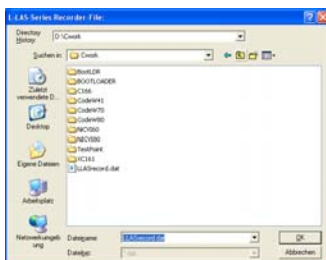

FILE button

A click on the FILE button opens a new dialog window for entering the file name and setting the directory for the output file. The currently selected directory and the file name of the output file are shown in a text display beside the FILE button.

d:\Programme\RECORD.DAT

START STOP

Automatic recording can be started by pressing the START button. If recording should be stopped before the maximum number defined by SAMPLES is reached, this can be done by clicking on the STOP button.

SAMPLE:

Numeric display field showing the current number of read measurement values.

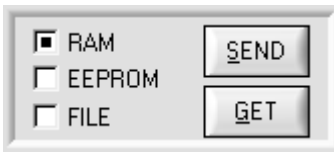

PARAMETER TRANSFER:

This group of function buttons is used for transferring parameters between the PC and the *L-LAS-TB control unit* through the serial RS232 interface.

SEND:

When the SEND button is clicked, the parameters currently set on the user interface are transferred to the *L-LAS-TB control unit*.

The target of data transfer is determined by the selected radio-button (RAM, EEPROM, or FILE).

GET:

When the GET button is clicked, the setting parameters are transferred from the *L-LAS-TB control unit* to the PC and are updated on the user interface. The source of data transfer again is determined by the selected radio-button:

RAM:

The currently set parameters are written to the volatile RAM memory of the *L-LAS-TB control unit*, or they are read from the RAM and transferred to the PC. Please note: The parameters set in the RAM will be lost when the power supply at the *L-LAS-TB control unit* is turned off.

EEPROM:

The currently set parameters are written to the non-volatile EEPROM memory of the *L-LAS-TB control unit*, or they are read from the EEPROM and transferred to the PC. Parameters that are saved in the EEPROM will not be lost when the power supply is turned off.

If parameters are read from the EEPROM of the *L-LAS-TB control unit*, these must be written to the RAM of the *L-LAS-TB control unit* by selecting the RAM button and then clicking on SEND. The *L-LAS-TB control unit* then continues to operate with the set RAM parameters.

FILE:

When the FILE radio-button is selected, a click on the SEND/GET button opens a new file dialog on the user interface. The current parameters can be written to a freely selectable file on the hard disk of the PC, or parameters can be read from such a file.

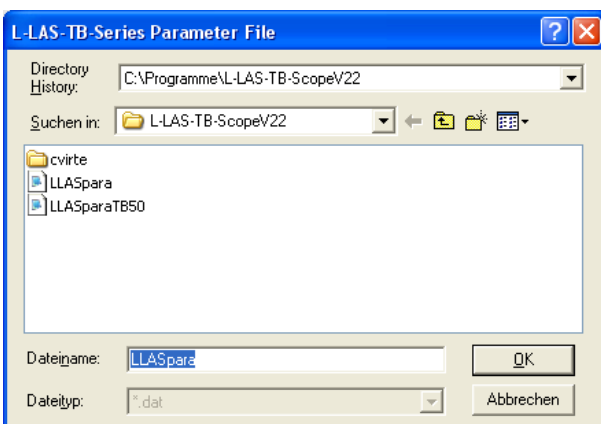

FILE dialog window:

The standard output file for the parameter values has the file name "LLASpara.dat".

The output file can be opened e.g. with the standard Windows "Editor" program.

3.2 Numeric and graphic display elements:



VIDEO button:

After a click on the VIDEO button, the intensity profile measured at the CCD receiver is transferred to the PC and is shown as a red curve in the graphic display window.

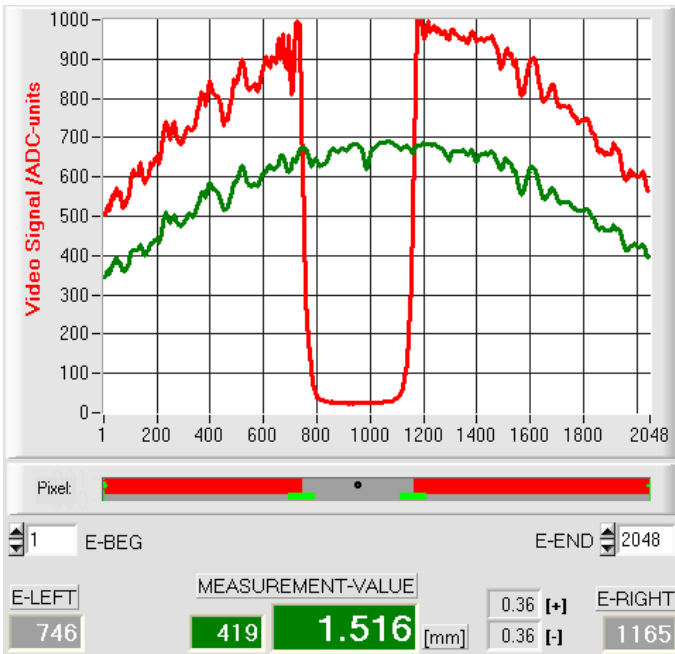

The y-axis shows the analog signals of the individual pixels. The analog values (video signals) of the CCD line are converted by means of an AD converter with 10-bit resolution, which results in a y-axis value range of 0 ... 1023.

The currently set video threshold (V-THD) is shown as a green horizontal line in the graphic display. The edge values (pixels) are derived from the intersection points of the intensity profile (red line) with the video threshold (green line).

The x-axis shows a virtual representation of the individual pixels of the CCD line (for example: Pixel 1 .. 2048).

Because of the limited data transfer rate of the serial interface (19200 Baud/s) the graphic display window can only be updated every second.

Beneath the graphic display window there is another display element that shows the currently detected shadowed areas and the illuminated areas of the CCD line. Furthermore the currently detected edge position is indicated in this display element by way of a black circular cursor. A green horizontal bar represents the width of the tolerance band that is currently set around the teach value.

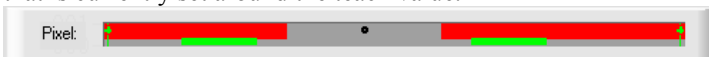

E-LEFT:

Numeric display field that shows the current left edge position.



E-RIGHT:

Numeric display field that shows the current right edge position.



M-VALUE:

Numeric display field that shows the current measurement value (depending on the set evaluation mode).

The left numeric display field shows the current measurement value in pixels, whereas the right display field shows the measurement value converted into millimeters.

Besides, the upper and lower tolerance limits are displayed.



RUN button:

After a click on the RUN button, the current measurement data will be transferred from the L-LAS-TB sensor to the PC via the serial interface.

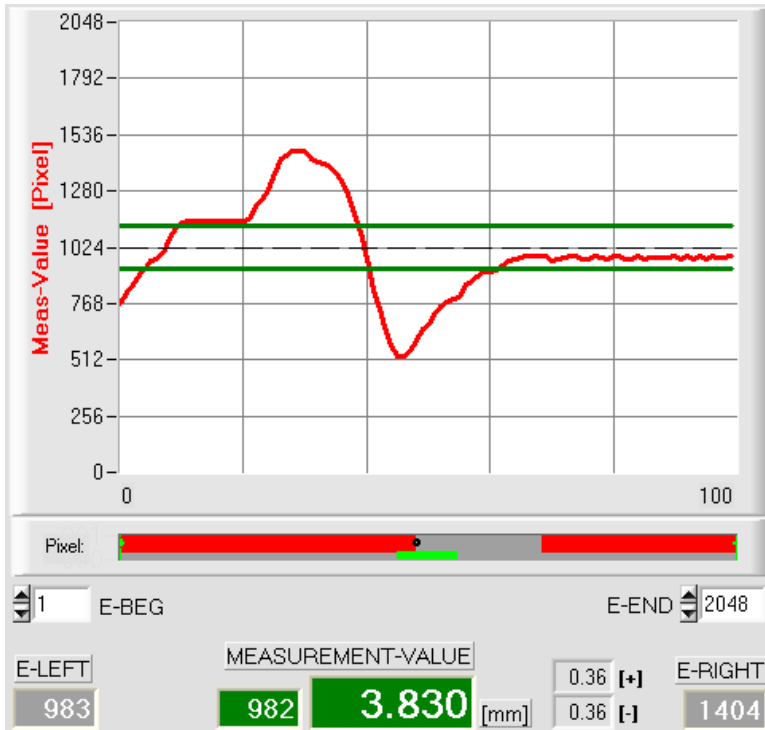

After a click on the RUN button the current measurement value is shown in the graphic display window in "scroll mode". In the form of a red curve the measurement values pass through the graphic display window from the right to the left.

The division of the y-axis corresponds with the pixels of the CCD line, or with the virtual number of sub-pixels of the line. In the graphic display the current measurement value (M-VALUE=717) is shown at the right end at the x-value of 100.

The current setpoint value (TEACH value) is shown as a broken horizontal line.

In addition, the current tolerance window is represented by two horizontal green lines that are applied symmetrically around the setpoint value.

In "RUN mode" the length of the data frame is limited to 18 words (36 bytes), which allows faster updating of the numeric and graphic display elements.

Compared to "DATA mode", data transfer through the serial RS232 interface therefore does not take so much time (in DATA mode the intensity information for every pixel must be transferred).

3.3 Serial RS232 data transfer:

RS232 COMMUNICATION:

- Standard RS232 serial interface without hardware-handshake.
- 3-line-connection: GND, TXD, RXD.
- Speed: 19200 baud, 8 data bits, no parity bit, 1 stop bit in binary mode, MSB first.



Attention !

The stable function of the RS232 interface (status message after program start) is a basic prerequisite for data transfer between the PC and the *L-LAS-TB control unit*. Due to the low data transfer rate of the serial RS232 interface (19200 bit/s) only slow changes of the analog values can be observed in the graphic display at the PC. In order to guarantee the maximum switching frequency of the *L-LAS-TB control unit* it is therefore necessary to stop the data exchange during the normal monitoring process (click on the STOP button).

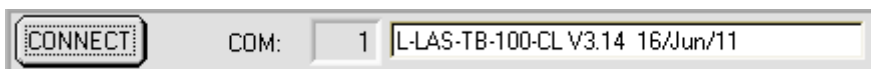

CONNECT:

When the software is started, it attempts to establish a connection to the *L-LAS-TB control unit* through the standard COM1 interface. If connection could be established successfully, the current firmware version is displayed in the status line.

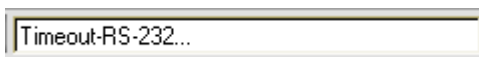

The serial connection between the PC and the *L-LAS-TB control unit* could not be established, or the connection is faulty.

In this case it should first be checked whether the *L-LAS-TB control unit* is connected to the power supply, and whether the serial interface cable is correctly connected to PC and control unit.

If the number of the serial interface that is assigned at the PC should not be known, interfaces COM1 to COM9 can be selected by using the CONNECT drop-down list.

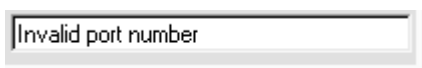

If there is an “Invalid port number” status message, the selected interface, e.g. COM2, is not available at your PC.



If there is a “Cannot open port” status message, the selected interface, e.g. COM2, may already be used by another device.

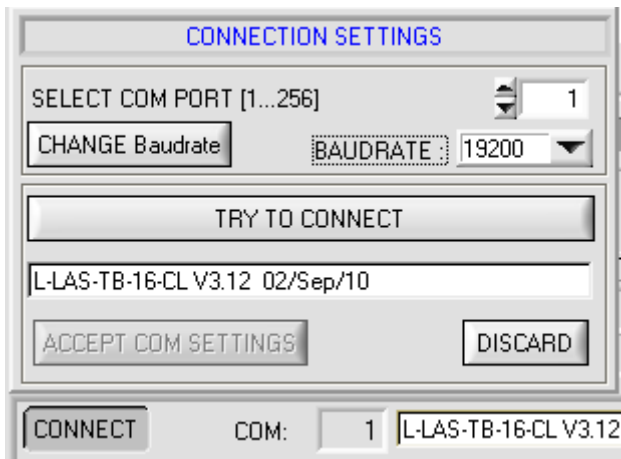

CONNECT

CONNECT-Taste:

A click on the CONNECT button opens a popup window where various settings for the serial interface can be made.

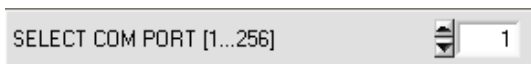

Setting of the current COM port number. Possible value range: 1...256.



After a click on this button the software tries to establish a connection with the sensor hardware by way of the currently set baud rate and the currently set COM port.

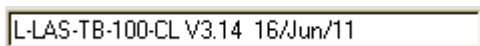

If connection could be successfully established, a firmware status message is displayed in the status line.



A click on the ACCEPT COM SETTINGS button saves the current settings in the L-LAS-TB-Scope PC software. The popup window will then be closed.

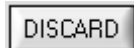

A click on the DISCARD button closes the CONNECT popup window without saving any new values. The settings for baud rate and COM port number are reset to the previous values



Baud rate setting at the sensor: Possible setting values are 9600Baud, 19200Baud, 38400Baud, 57600Baud or 115200 Baud.



The baud rate will only be changed at the sensor hardware when the CHANGE Baudrate button is pressed. When the baud rate change at the sensor was successful, a corresponding status message will be displayed.



The baud rate change is performed in the volatile RAM memory of the sensor. If the baud rate should be permanently stored, it must be written to the sensor's EEPROM memory. To do this, select EE and press the SEND button.

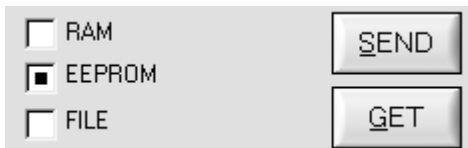

3.4 L-LAS-TB-Scope as an aid for sensor adjustment:



VIDEO:

After a click on the VIDEO button, the fine adjustment between the *L-LAS transmitter unit and the receiver* can be observed in the graphic display window. Because of the limited data transfer rate of the RS232 interface the display window can only be updated every second.



STOP:

A mouse-click on the STOP button stops the data transfer between the *L-LAS-TB control unit and the PC*.

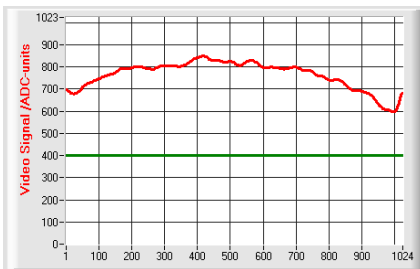

Optimal adjustment:

In the graphic display window the intensity profile is shown as a red curve. The numerical values 1 ... 1024 on the x-axis represent the individual pixels of the CCD line. The analog values of the CCD line are converted by way of an AD converter with 10-bit resolution, which results in a y-axis value range of 0 ... 1023.

As can be seen in the picture on the left, the CCD pixels 1 to 1024 are uniformly illuminated by the transmitter beam.

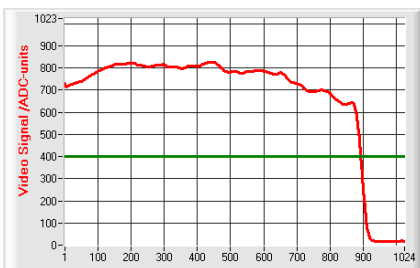

Wrong adjustment - right:

The transmitter beam no longer sufficiently illuminates the pixels at the right end of the CCD line. The red curve (intensity profile) in this part clearly is under the video threshold. The alignment of the laser transmitter unit or the CCD receiver unit must be readjusted in such a way that the pixels at the right end are illuminated again.

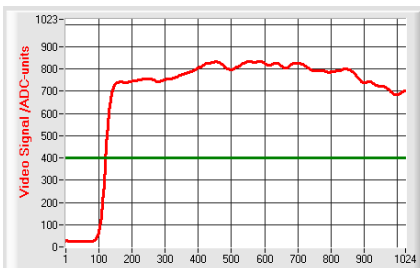

Wrong adjustment - left:

The transmitter beam no longer sufficiently illuminates the pixels at the left end of the CCD line. The alignment of the laser transmitter unit or the CCD receiver unit must be readjusted in such a way that the pixels at the left end are illuminated again.

3.5 L-LAS-TB-Scope as an aid for transmitter power adjustment:

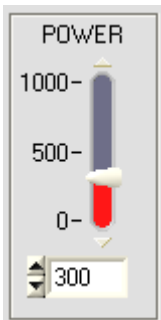

POWER:

In this field the laser power at the laser transmitter unit of the *L-LAS-TB sensor* can be set by using the slider or by entering a numerical value in the respective input field.



Attention !

The laser power at the transmitter unit of the *L-LAS-TB sensor* is only updated when the **SEND** button is pressed.



VIDEO:

After a click on the **VIDEO** button, the current intensity profile is transferred from the *L-LAS-TB sensor* to the PC and is shown in the graphic display window. When the **VIDEO** function is active, the sensor's laser power can be changed (press the **SEND** button), and the effect of such a change can be observed in the intensity profile.



Optimal adjustment:

In the graphic display window the intensity profile is shown as a red curve. Through the complete CCD line the intensity characteristic lies above the video threshold (green line).

In the shadowed area the intensity characteristic is at low ADC values (offset <120).

In the shadowed areas the intensity characteristic does not show any sporadic "spikes".

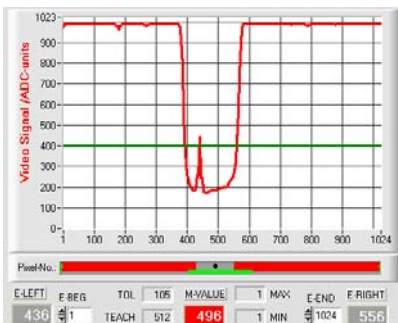

Transmitter power too high:

The transmitter beam overloads individual pixels of the CCD line. There are sporadic short upward "spikes" in the shadowed areas.

If such "spikes" intersect with the green horizontal video threshold, there will be incorrect measurements!

Remedy:

Reduce the laser power in steps, until such "spikes" in the shadowed area do not occur any more.

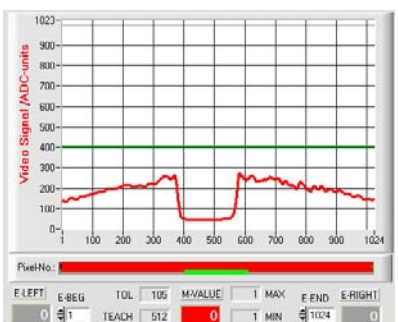

Transmitter power too low:

The intensity profile of the CCD line completely lies under the video threshold (green horizontal line).

The *L-LAS-TB sensor* does not detect any edges (bright/dark transitions, i.e. intersections between red curve and green video threshold) in the image of the beam.

Remedy:

Increase the laser power in steps, at the same time observing the intensity characteristic, until the red curve (intensity profile) from pixel 1 to pixel 1024 lies above the video threshold.

4 Evaluation modes

4.1 LEFT-EDGE



L-EDGE:

The first detected edge in the intensity profile of the CCD line is evaluated.

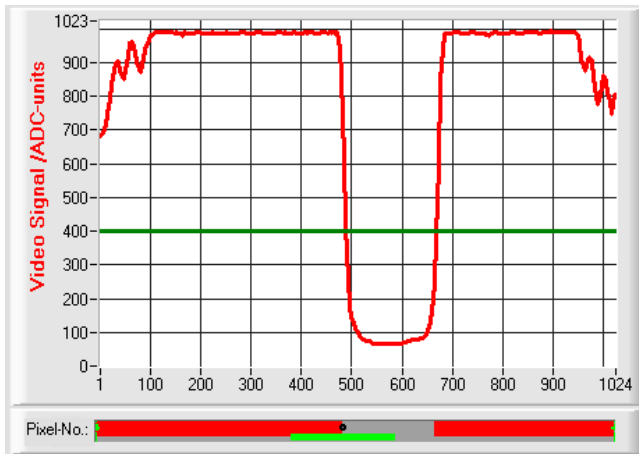

The criterion for edge detection is the transition between illuminated and shadowed areas in the intensity characteristic of the CCD line.

The one pixel of the CCD line at which this bright/dark transition takes place can be determined from the intersection between the video threshold (green horizontal line) and the intensity characteristic (red curve).

In the example picture on the left, the first bright/dark transition is detected at pixel no. 488.

The current measurement value M-VALUE = E-LEFT is shown in the red numeric display element.

4.2 RIGHT-EDGE



R-EDGE:

The second detected edge in the intensity profile of the CCD line is evaluated.

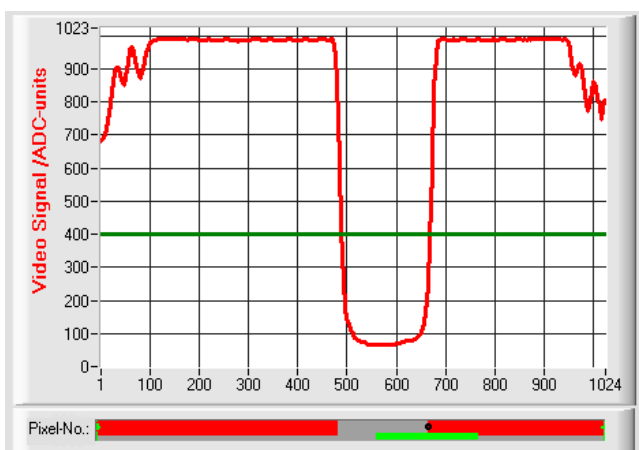

The one pixel of the CCD line at which the second bright/dark transition takes place can be determined from the intersection between the video threshold (green horizontal line) and the intensity characteristic (red curve).

In the example picture on the left, the second bright/dark transition is detected at pixel no. 668.

The black dot-shaped cursor beneath the graphic display window represents the current right edge (R-EDGE) of the shadowed area.

The current measurement value M-VALUE = E-RIGHT is shown in the red numeric display element.

4.3 WIDTH



WIDTH:

The difference between the second edge and the first edge in the intensity profile of the CCD line is evaluated.

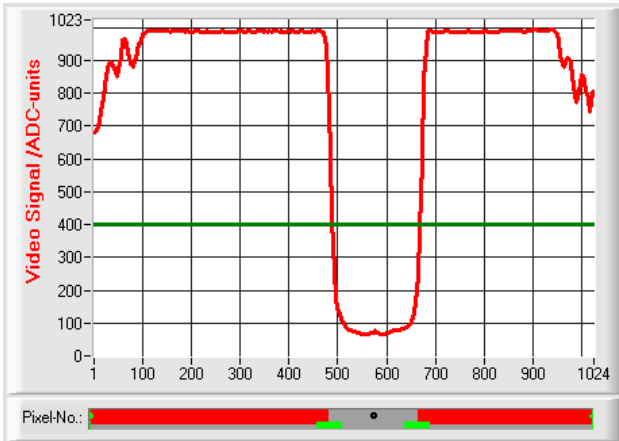

E-LEFT	E-BEG	TOL	52	M-VALUE	1	MAX	E-END	E-RIGHT
488	1	TEACH	180	180	1	MIN	1024	668

The two pixels where the bright/dark transition occurs can be determined from the two intersections between the video threshold (green horizontal line) and the intensity characteristic (red curve).

In the example picture on the left, the second bright/dark transition is detected at pixel no. 668, and the first bright/dark transition at pixel no. 488.

The difference is calculated as follows:

$$WIDTH = E_RIGHT - E_LEFT$$

The current measurement value M-VALUE = WIDTH is shown in the red numeric display element.

4.4 CENTER



CENTER:

The mean value of the first and the second edge is used as measurement value: $CENTER = (R-EDGE+L-EDGE)/2$

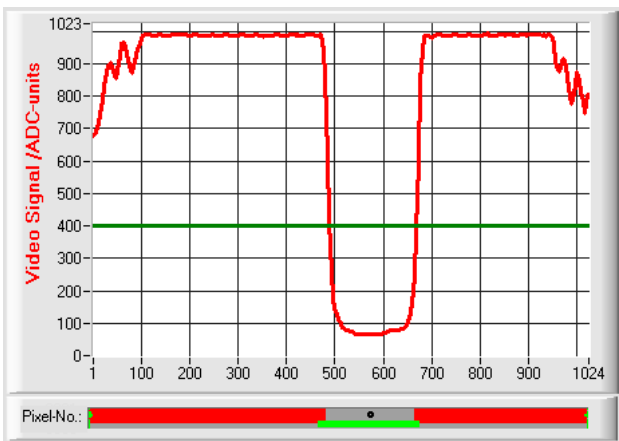

E-LEFT	E-BEG	TOL	104	M-VALUE	1	MAX	E-END	E-RIGHT
488	1	TEACH	576	576	1	MIN	1024	668

The two pixels where the bright/dark transition occurs can be determined from the two intersections between the video threshold (green horizontal line) and the intensity characteristic (red curve).

In the example picture on the left, the second bright/dark transition is detected at pixel no. 668, and the first bright/dark transition at pixel no. 488.

The mean value is calculated as follows:

$$CENTER = \frac{(E_RIGHT + E_LEFT)}{2}$$

The current measurement value M-VALUE = CENTER is shown in the red numeric display element.

5 Function of the data recorder

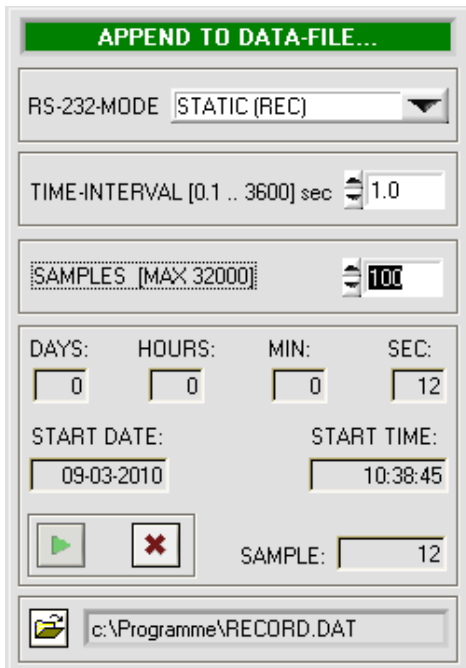

The screenshot shows the 'APPEND TO DATA-FILE...' window with the following fields and controls:

- RS-232-MODE:** A dropdown menu set to 'STATIC (REC)'.
- TIME-INTERVAL:** A numeric input field set to 1.0, with a range of [0.1 .. 3600] sec.
- SAMPLES [MAX 32000]:** A numeric input field set to 100.
- DAYS:** 0
- HOURS:** 0
- MIN:** 0
- SEC:** 12
- START DATE:** 09-03-2010
- START TIME:** 10:38:45
- Buttons:** A green play button (START) and a red 'X' button (STOP).
- SAMPLE:** A numeric display field showing 12.
- File Path:** c:\Programme\RECORD.DAT



Four buttons labeled PARA1, PARA2, REC, and CALIB are shown in a row.

A click on the REC button opens the DATA-RECORDER window on the user interface.



A close-up of the RS-232-MODE dropdown menu, showing 'STATIC (REC)' selected.

RS-232-MODE:

Drop-down function field for setting the data request at the *L-LAS-Sensor* hardware.

STATIC(REC):

The sensor does not automatically send measurement data through the RS-232 interface. Every individual data transfer is started by the PC/PLC with command no. 18. Upon this request the sensor sends a single data frame (36 bytes) to the PC/PLC.

TRIG-INO L/H (REC):

A single data frame (36 bytes) is sent to the PC/PLC at every LOW/HIGH edge at digital input IN0/pin3/green.

TRIG-INO L/H (3-BYTE), CONTINUOUS (3-BYTE):

Cannot be used with the data recorder!

High-speed 3-BYTE data transfer -> see chapter 5.2.

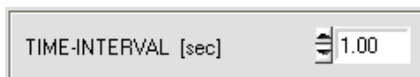

A close-up of the TIME-INTERVAL [sec] input field, showing the value 1.0.

TIME-INTERVAL [sec]:

This numeric input field can be used to set a time interval in seconds. When this time interval is over, the PC software automatically requests measurement data from the sensor (command 18). The PC/PLC waits until the complete data frame (36 bytes) from the sensor has arrived in the input buffer of the serial interface of the PC. Then the PC saves the new measurement data in an output file on the hard disk. Minimum value: 0.1 [sec]. When the TIME-INTERVAL [sec] is over, the PC/PLC initiates a new transfer.



A close-up of the SAMPLES [MAX 32000] input field, showing the value 100.

SAMPLES [MAX 32000]:

Numeric input field for presetting the maximum number of measurement values that should be saved. The value range is 10 to 32000.



Two numeric display fields: START DATE (02-06-2008) and START TIME (16:48:31).

Numeric display fields providing information about the start date and start time. These displays are updated when the START button is pressed.

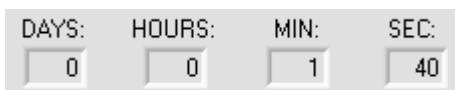

Four numeric display fields showing time interval components: DAYS (0), HOURS (0), MIN (1), and SEC (40).

Numeric display elements showing the time interval in seconds that has passed since the recorder function was started.

5.2 3-Byte RS232 data transfer

Fast data transfer of digital values (pixel values) from the *L-LAS-TB sensor* to the PLC can be realised by way of two RS-232-MODE (3-byte) operating modes. With a baud rate of 19200 kBit/s the transfer of a 3-byte data frame takes approx. 1.0ms, with 115.2 kBit/s data exchanged takes approx. 0.2ms.

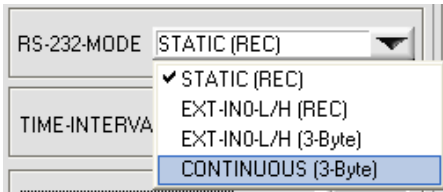

3-byte data transfer:

EXT-IN0-L/H (3-Byte):

3-byte data transfer is triggered by a low/high or high/low edge (hardware specific) at IN0/pin3/green/ at the 8-pole PLC connector.

CONTINUOUS (3-Byte):

Continuous 3-byte data transfer during the main program run.

Setting of the RS-232 interface:

- Standard RS-232 serial interface, no hardware handshake
- 3-wire-connection: GND, TXD, RXD
- Speed: 9600 baud, 19200 baud, 38400 baud, 57600 baud or 115200 baud
- 8 data-bits, NO parity-bit, 1 stop-bit, binary-mode.

Transmission format of 3-byte data transfer:

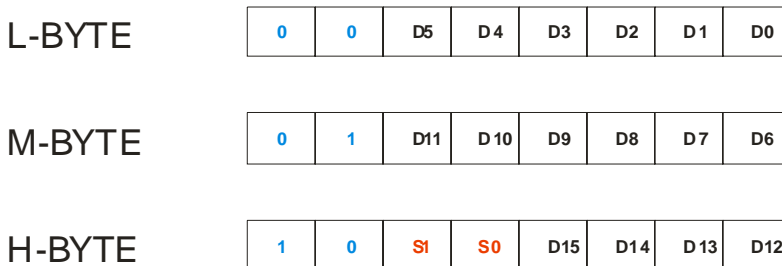
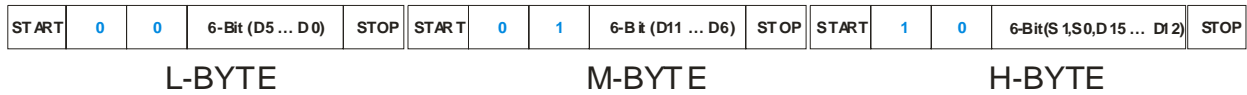

Extraction of the digital value (D0 – D15):

The first two bits are used for recognising the LOW-byte (0|0), Middle-byte (0|1) and High-byte (1|1). The High-byte also transfers two status bits (S1|S0).

Digital value DW = D0 ... D15

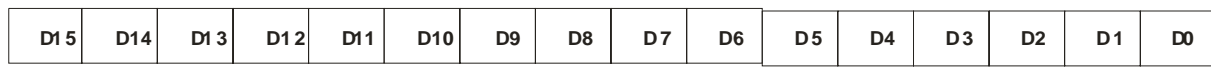

Conversion of digital value into mm – value:

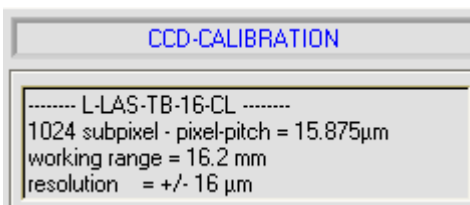

The millimetre value can be determined from the digital value and the pixel pitch. The pixel pitch is sensor-specific.

Example: *L-LAS-TB-16-CL* with 15.875µm pixel pitch:

Measurement value [mm] = DW * 0.015875mm

Examples for the extraction of the digital value:

Output of a typical hyperterminal program – The object is placed at two different positions in the operating range:

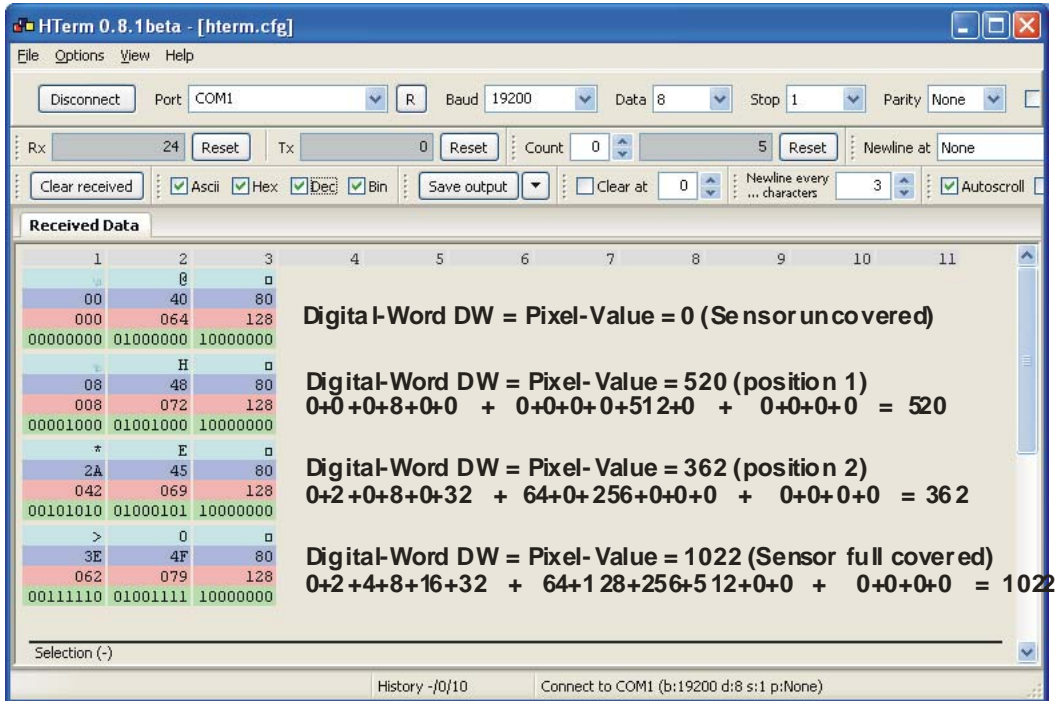

6 Two-point calibration

CCD-CALIBRATION

----- L-LAS-TB-16-CL -----
 1024 subpixel - pixel-pitch = 15.875µm
 working range = 16.2 mm
 resolution = +/- 16 µm

DIGITAL-COMPARATION-MODE
 ANALOG-DIGITAL-CONV-MODE

DIAMETER 1 PIXEL_1:
 [µm]

DIAMETER 2 PIXEL_2:

SLOPE-VALUE A [µm/pixel]

INTERSECTION B [µm]

PARA1
PARA2
REC
CALIB

CCD-CALIBRATION:

A click on the CALIB button opens the CCD-CALIBRATION window. This CCD-CALIBRATION window allows two-point calibration at the sensor. The purpose of two-point calibration is to provide and output a highly accurate width measurement value in micrometers at the sensor in evaluation mode EVALMODE=WIDTH.

EVAL-MODE: ▼

The problem with width measurement is that depending on the set video threshold and the set transmitter power, the measurement value for the width information will be calculated differently. This is caused by the constantly rising analog characteristic (slope) of the video signal in the transition area between object shading and direct laser light impingement on the pixels of the CCD line. The object width is calculated indirectly from the two intersection points of the video signal characteristic (red curve) with the green horizontal video threshold.



High video threshold, the object appears wider in the "shadow zone". Measured value = 180 pixel. The measured value in µm is calculated from this by multiplying the number of pixels with the respective pixel pitch.

$$M\text{-VALUE} = 180 \text{ pixel} \times 15.875\mu\text{m} = 2.86 \text{ mm}$$

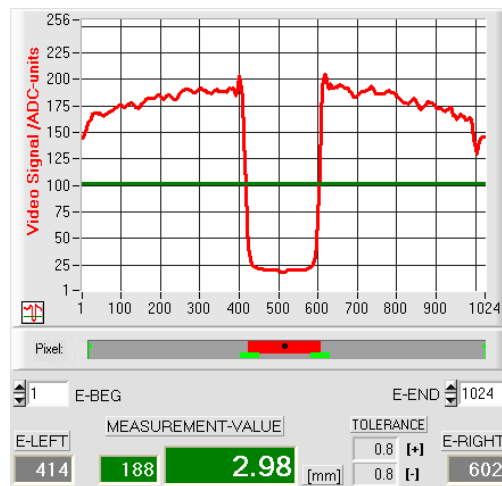

Low video threshold, the object appears somewhat narrower in the "shadow zone". Measured value = 188 pixel. The measured value in µm is calculated from this by multiplying the number of pixels with the respective pixel pitch.

$$M\text{-VALUE} = 188 \text{ pixel} \times 15.875\mu\text{m} = 2.98\text{mm}$$

In order to compensate this problem, two-point calibration can be performed with a fixed transmitter power (POWER) and a fixed video threshold (V-THD).

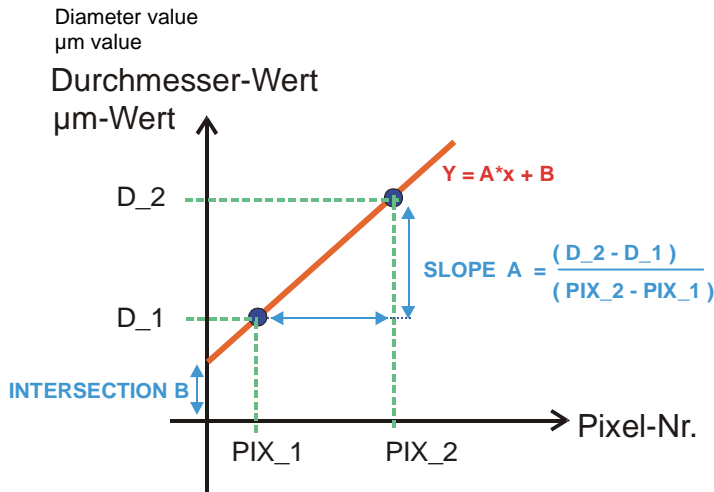

In two-point calibration, a mean straight line through two points is calculated on the basis of two known objects (dimensions in µm are known) of different width.

The most important parameters of this mean straight line are its slope (SLOPE-VALUE A) and, if applicable, the Y-axis section B.

The slope A indicates the change in micrometers per change of pixel. The Y-axis section B (INTERSECTION-VALUE B) defines the zero-point offset.

DIAMETER 1 PIXEL_1:

2500 [µm] Accept 160

e.g. object of 2.5mm diameter results in 160 pixels covering

DIAMETER1

When the ON/OFF checkmark is activated, the object with the smaller diameter should be placed in the center of the operating range. The smaller object for example should cover 20-40% of the maximum operating range.

The known diameter value in micrometers must then be entered in the numerical input field.

Accept

A click on the Accept Object 1 button saves the first value pair (DIAMETER-1, PIXEL_1).

DIAMETER 2 PIXEL_2:

7100 Accept 448

e.g. object of 7.1mm diameter results in 448 pixels covering

DIAMETER2:

When the ON/OFF checkmark is activated, the object with the bigger diameter should be placed in the center of the operating range. The bigger measuring object for example should cover 60-80% of the maximum operating range.

The known diameter value in micrometers must then be entered in the numerical input field.

Accept

A click on the Accept Object 2 button saves the second value pair (DIAMETER-2, PIXEL_2).

RUN

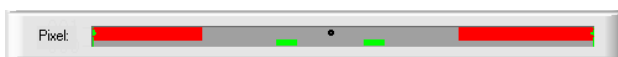

When calibration is started, the actions of the RUN button on the user interface are performed automatically. In the graphic display section under the large "scroll graph" the centered placing of the objects in the operating range of the sensor can be checked. The area with the grey background (shadow area) represents the position of the object. The pixels that are hit by the laser beam are represented as red areas.

SLOPE-VALUE A [$\mu\text{m}/\text{pixel}$]		CALC
15.875	15.972	
INTERSECTION B [μm]		SAVE
0	-56	EXIT!

CALC

After a click on the CALC button, the slope and the Y-axis section are calculated anew from the two known point pairs of the objects.

The newly calculated values for the slope (SLOPE-VALUE A) and for the offset (INTERSECTION B) are shown in the display fields with gray background.

The previously set values are shown in the numerical input fields with white background.

SAVE

SAVE

If the newly calculated values make sense, they can be saved to the RAM memory of the control unit in the sensor by clicking on the SAVE NEW VALUES button.

EXIT!

EXIT!

If the last calibration should be discarded, this can be done by clicking on the EXIT! button.

<input type="checkbox"/> RAM	SEND
<input checked="" type="checkbox"/> EEPROM	
<input type="checkbox"/> FILE	GET



The last calculated calibration values are only saved to the NON-VOLATILE EEPROM memory of the control unit when EEPROM is selected as the target and the SEND button is then pressed!

EXIT!

EXIT!

Exits calibration.

Manual entering of calibration data:

SLOPE-VALUE A [$\mu\text{m}/\text{pixel}$]		CALC
15.972	0.000	
INTERSECTION B [μm]		SAVE
-56	0	EXIT!

The calibration data also can be modified manually at the control unit of the sensor.

When the PARA II pop-up window has been opened, the numerical values can at any time be changed manually in the corresponding numerical input fields, without having to go through the calibration procedure.

<input checked="" type="checkbox"/> RAM	SEND
<input type="checkbox"/> EEPROM	
<input type="checkbox"/> FILE	GET

The newly entered calibration values must first be activated at the control unit by clicking on the SEND button.

7 Annex

7.1 Laser warning

LASER WARNING

Solid-state laser, $\lambda=670$ nm, 1mW max. optical power,
laser class 2 acc. to EN 60825-1

Therefore no additional protective measures are required for the use of these laser transmitters.



LASER RADIATION
DO NOT STARE INTO THE BEAM
CLASS II LASER PRODUCT

7.2 Function of the Teach/Reset button

The housing of the *L-LAS-TB* sensor features a pushbutton with two functions:

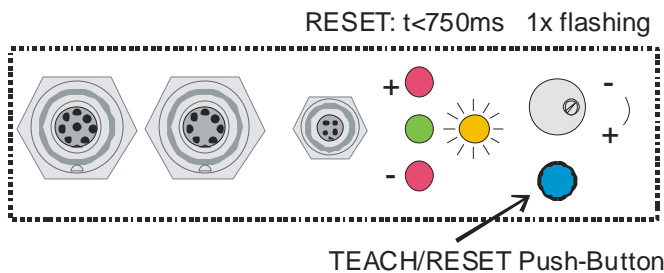

RESET function:

When the button is pressed for a short time ($t < 750\text{ms}$), the current maximum and minimum values are reset.

A hardware/software RESET is not performed!

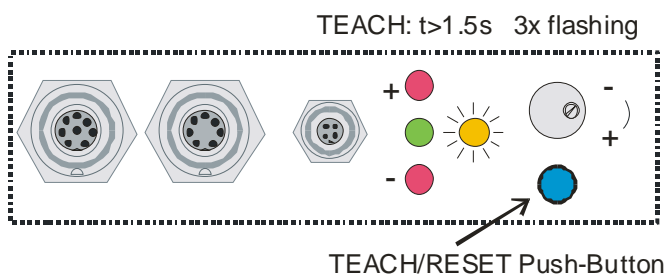

TEACH function:

When the button is pressed for a longer time ($t > 1.5\text{s}$), the current edge coverings are stored as teach value in the RAM memory. When the teach process has been performed successfully, the green LED blinks three times.

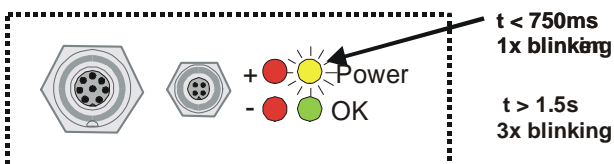

(CL) Compact-Line types:

These types have no teach/reset button at the housing. The teach/reset functionality can be performed through digital input IN1/yel/pin4.

Reset: LED/yellow blinks shortly 1x
Teach: LED/yellow blinks shortly 3x

7.3 Function of the Tolerance potentiometer:

The housing of the *L-LAS-TB sensor* features a potentiometer for setting the tolerance band width.

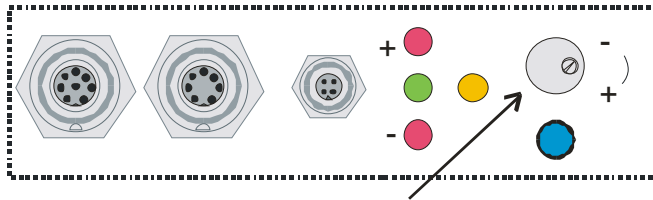

Tolerance - Potentiometer

TOLERANCE potentiometer:

Turning the potentiometer clockwise increases the tolerance band width.
Turning it counter-clockwise decreases the tolerance band width.

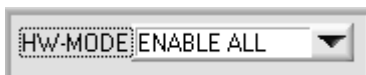

The potentiometer must be activated (switch position **ENABLE ALL** or **ENABLE TOL SET**) in order to use it for setting the tolerance band width at the *L-LAS-TB sensor*.

7.4 Function of digital inputs IN0 and IN1

The *L-LAS-TB sensor* has two digital inputs IN0 and IN1 that can be contacted through the 8-pole female connector (type Binder 712).

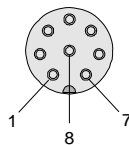
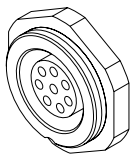

Pin:	Color:	Assignment:
1	white	0V (GND)
2	brown	+Ub (+24VDC ± 10%)
3	green	IN0 (EXT TRIGGER)
4	yellow	IN1 (TEACH/RESET)
5	gray	OUT0
6	pink	OUT1
7	blue	OUT2 [in case of CL-type: 0V (GND)]
8	red	ANALOG (0...+10V or 4...20mA)

DIGITAL INPUT IN0 (pin3/green) EXT-TRIGGER:

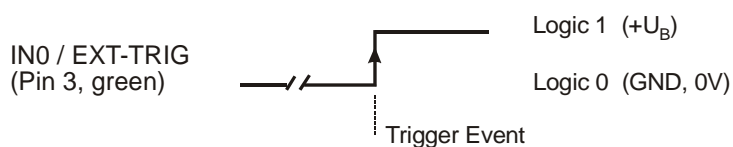

External edge-controlled (LOW/HIGH) triggering of measurement value evaluation through digital input IN0.

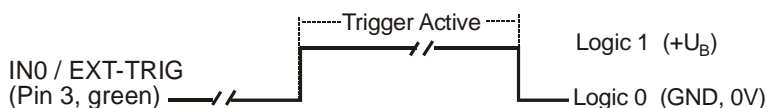

External triggering of measurement value evaluation through a HIGH level (+Ub) at digital input IN0.

DIGITAL INPUT IN1 (pin4/yellow) TEACH/RESET:

RESET function:

When a HIGH pulse of less than **750 ms** duration is applied, the RESET function is performed at the *L-LAS-TB sensor*. This resets the current maximum and minimum values (drag pointer). A hardware/software RESET is not performed! When a RESET pulse is detected, the yellow LED flashes shortly one time.

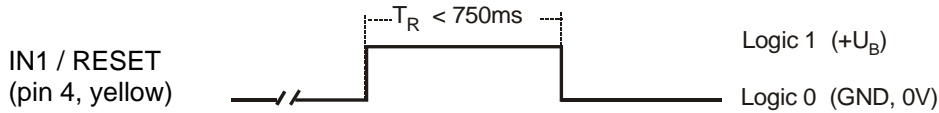

TEACH function:

When a HIGH pulse of more than **1.5s** duration is applied, the TEACH function is performed at the *L-LAS-TB sensor*. When a TEACH pulse is detected, the green LED at the housing flashes shortly three times.

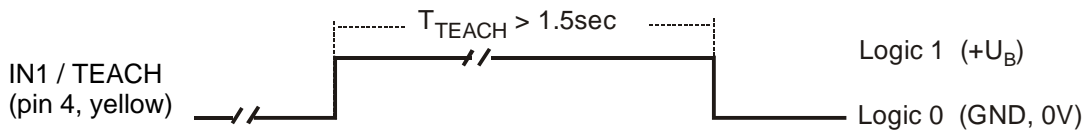

7.5 Connector assignment

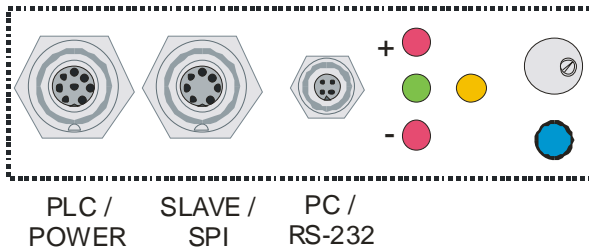

At the housing of the *L-LAS-TB* sensor there is a female connector for power supply connection (8-pol. type Binder 712) and a second female connector for connecting a serial RS232 connecting cable (4-pol. type Binder 707).

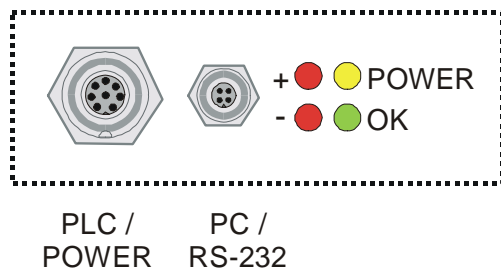

L-LAS-TB Compact-Line types (*L-LAS-TB-...-CL*)

RS232 connection to the PC:

4-pole M5 female connector type Binder 707

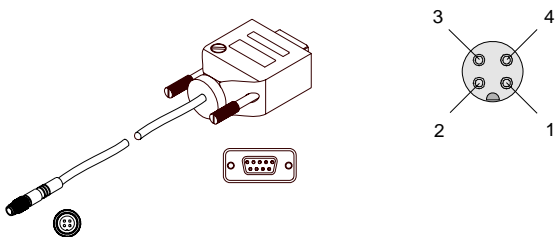

Pin:	Assignment:
1	+24VDC (+Ub)
2	0V (GND)
3	RxD
4	TxD

Connecting cable:

cab-las4/PC (length 2m, cable jacket: PUR)

Interface to PLC/voltage supply:

8-pole female connector type Binder 712

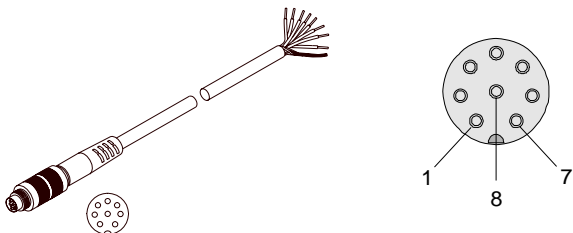

Pin:	Color:	Assignment:
1	white	0V (GND)
2	brown	+Ub (+24VDC ± 10)
3	green	IN0 (EXT TRIGGER)
4	yellow	IN1 (TEACH/RESET)
5	grey	OUT0
6	pink	OUT1
7	blue	OUT2 [in case of CL type: 0V (GND)]
8	red	ANALOG (0 ... +10V or 4...20mA)

Connecting cable:

cab-las8/SPS (length 2m, cable jacket: PUR)

7.6 RS232 interface protocol

RS232 Interface-Protocol PC ↔ L-LAS-TB Sensor Firmware Version 3.1x

- Standard RS232 serial interface, no hardware handshake
- 3-wire-connection: GND, TXD, RXD
- Speed: 9600 baud, 19200 baud, 38400 baud, 57600 baud or 115200 baud
- 8 data-bits
- NO parity-bit
- 1 stop-bit
- binary-mode.

The control device (PC or PLC) have to send a frame of 18-words (1 word = 2 byte = 16 bit) to the L-LAS-TB hardware. All words must be transmitted in binary format. The most significant byte must be transmitted first (MSB-first).

METHOD:

The microcontroller of the L-LAS-TB sensor is permanently reading (polling) the input-buffer of the RS-232 module. If the incoming word = 0x0055 (0x55 hexadecimal = 85 decimal), this is interpreted as the synchronisation-event (<sync-word>). After this, the 2.nd word with the order number (<order-word>) is read in by the microcontroller.

The order word (<order-word>), is followed by a further word, which contents parameter-set number 0 or 1 (<para-set>). The para-set-word is followed by 15 further words <parameter-word>, which contents the actual parameters.

After reading the complete data-frame (18-words = 36 bytes), the L-LAS-TB sensor-hardware executes the order which is coded at the 2.nd word (<order-word>) of the data-frame (c.f. order-table).

DATA FRAME: PC/PLC → SENSOR (18-Words=36Bytes, MSB first)

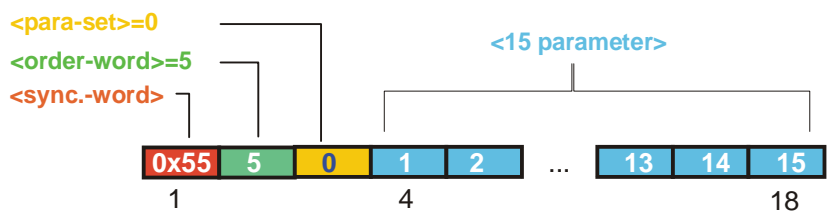

Format of the data-frame: <para-set = 0>		
Word	Meaning	Comment
1	<sync-word>	hex-code 0x55, binary=0000 0000 0101 0101, dec.=85
2	<order-word>	Order word (c.f. table below)
3	<parameter-set> = 0	0 = parameter-set number 0
4	POWER	Laser intensity (0 ... 1000)
5	POWER-MODE	Transmitter-mode: (0 = STATIC), (1=DYNAMIC), not used
6	POLARITY	Polarity setting for OUT0, OUT1,OUT2 (0=DIRECT, 1=INVERSE)
7	EVAL-MODE	Evaluation mode (0=L-EDGE, 1=R-EDGE, 2=WIDTH, 3=CENTER)
8	E-BEGIN	Evaluation start -pixel (1 .. E_END-1)
9	E-END	Evaluation end-pixel (E_BEG+1 .. SUBPIXEL)
10	TEACH-VALUE	Teach-value (1 ... SUBPIXEL)
11	TOLERANCE-HIGH VALUE	Upper-tolerance TOL-HIGH: (0 ... SUBPIXEL/2)
12	TOLERANCE-LOW-VALUE	Lower-tolerance TOL-LOW: (0 ... SUBPIXEL/2)
13	AVERAGE	Average-setting (1,2,4,8,16,32,64,128 or 256)
14	TRIGG-MODE	Trigger mode (0=CONTINUOUS, 1=EXT. IN0 L/H, 2=EXT.IN0 HIGH,3=SAVE VTHD, 4=OUTPUT WIDTH)
15	ANALOG-OUT	Analog-output-mode: (0=DIRECT 0..10V, 1=MAXIMA, 2=MINIMA, 3=MAX-MIN)
16	OPERATION-MODE	CCD-operation-mode (0=LOW-GAIN / 1=HIGH-GAIN)
17	HW-MODE	Enable/disable TOL-potentiometer and button at housing (DISABLE-ALL=0, ENABLE-ALL=1,ENABLE-BTN=2, ENABLE POTI=3)
18	VIDEO-THD-MODE	Video-threshold -mode 0=FIX, 1=AUTO

Format of the data-frame: <para-set = 1>		
Word .	Meaning	Comment
1	<sync-word> = 0x0055	hex-code 0x55, binary=0000 0000 0101 0101, dec.=85
2	<order-word>	Order-word (c.f. table below)
3	<parameter-set> = 1	1 = parameter-set-number 1
4	VIDEO-THD-FIX	Video-threshold (0 ... 100) percent of full ADC-range
5	VIDEO-THD-AUTO	Video-threshold (0 ... 100) percent of full ADC-range
6	RS-232-MODE	Data-recorder-mode: 0 = STAT, 1=EXT-IN0 L/H, 2=EXT-IN0 L/H (3-Byte), 3=CONTINUOUS (3-Byte)
7	RS-232-BAUD	Baudrate: 0=9600, 1=19200, 2=38400, 3=57600 , 4=115200 baud
8	SMOOTH-VIDEO-SIGNAL	Smooth video signal over (1,2,4,6,8,12,16,24,32,48 or 64) pixel
9	ANALOG-ZOOM	Zoom-mode for analog-output (0=DIRECT, 1=ZOOMx1, 2=ZOOMx2, 3=ZOOMx4, 4=ZOOMx8, 5=ZOOMx16, 6=WIN-5V, 7=WIN-10V)
10	Parameter 7	0 ,not used
11	Parameter 8	0 ,not used
12	Parameter 9	0 ,not used
13	Parameter 10	0, not used
14	Parameter 11	0, not used
15	SLOPE VALUE L-WORD	Slope value for calibration (x 1024), low-word
16	SLOPE VALUE H-WORD	Slope value for calibration (x1024), high-word
17	REF-OFFSET L-WORD	Intersection parameter with offset = 32767
18	REF-OFFSET H-WORD	Intersection parameter (not used)

Meaning of the 2.nd word of the data-frame: <order-word> ORDER-TABLE

value	Meaning / Action	
0	NOP	no operation
1	Send parameter from PC to L-LAS-RAM	18 words, PC ⇒ L-LAS-RAM
2	Get parameter from L-LAS-RAM	18 words, L-LAS-RAM ⇒ PC
3	Send parameter from PC to EEPROM	18 words, PC ⇒ L-LAS-EEPROM
4	Get parameter from EEPROM of L-LAS	18 words, L-LAS-EEPROM ⇒ PC
5	Echo check: Get echo of L-LAS	18 words, first word=0x00AA=170dec
6	Activate teach at L-LAS, store in RAM	18 words PC ⇒ L-LAS-RAM
7	Get software version info of L-LAS	72-bytes, L-LAS ⇒ PC
8	Get measured values out of L-LAS-RAM	18 words, L-LAS-RAM ⇒ PC
9	Get video-buffer info from L-LAS	64 words, L-LAS-RAM ⇒ PC
11	Reset maximum/minimum values at analog-output	18 words PC ⇒ L-LAS-RAM
13	Refresh auto-video-threshold to RAM or EEPROM	18 words PC ⇒ L-LAS-RAM
18	Get measured values from L-LAS-RAM (data-recorder)	18 words PC ⇒ L-LAS-RAM
190	Change RS232-baud-rate (L-LAS-RAM)	18 words PC ⇒ L-LAS-RAM

Examples for the data-transfer:

Echo check: <order-word> = 5

<order-word> = 5
 Echo check: L-LAS sensor sends echo: word=0x00AA=170 to PC

DATA FRAME: PC → SENSOR (18-Words=36Bytes, MSB first)

<para-set>=0
<order-word>=2
<sync.-word>

0x55
5
0
0
0
0
0
...
0
0
0
0

DATA FRAME: SENSOR → PC (18-Words=36Bytes, MSB first)

ECHO=0xAA=170
<sync.-word>

0x55
170
0
0
0
0
0
...
0
0
0
0

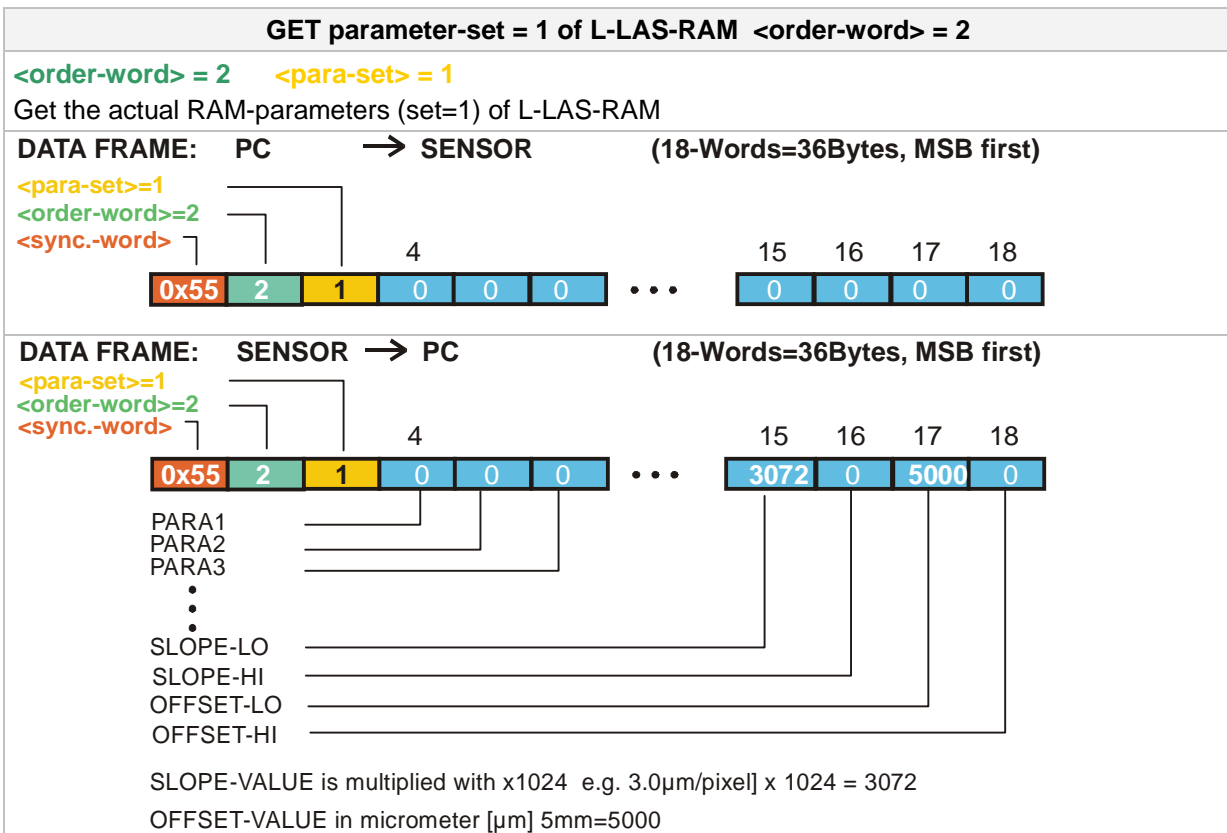
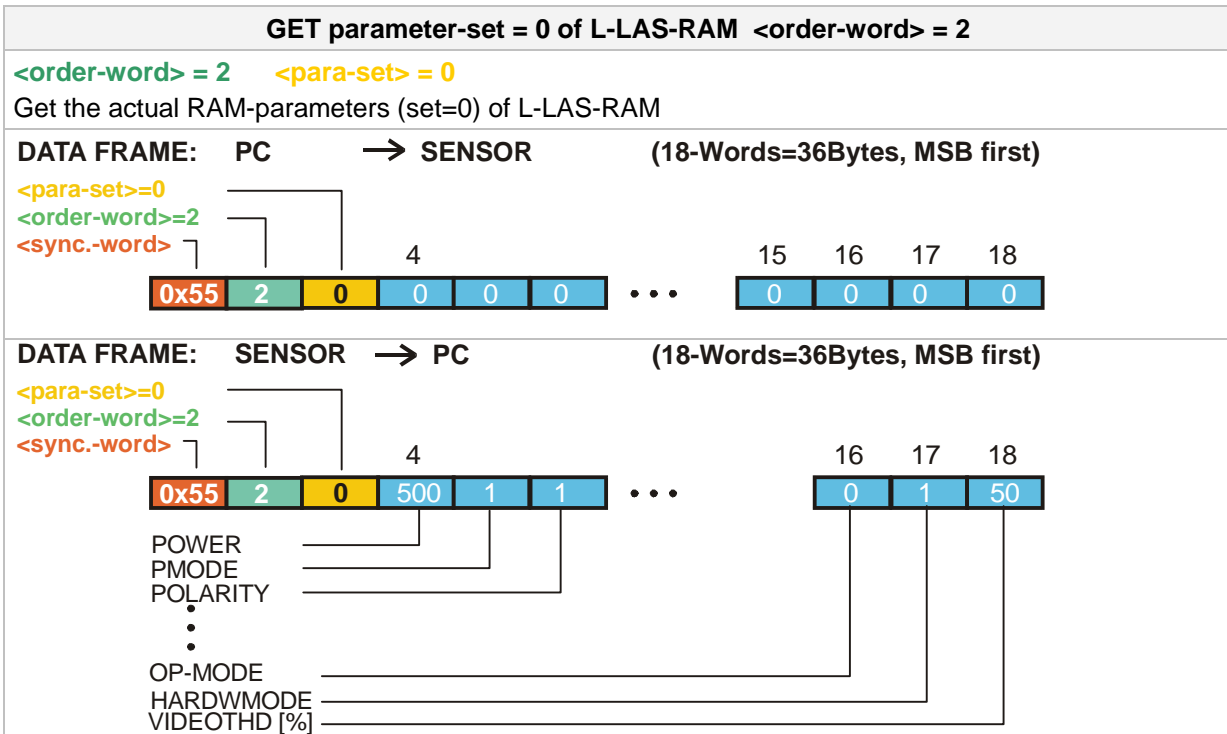

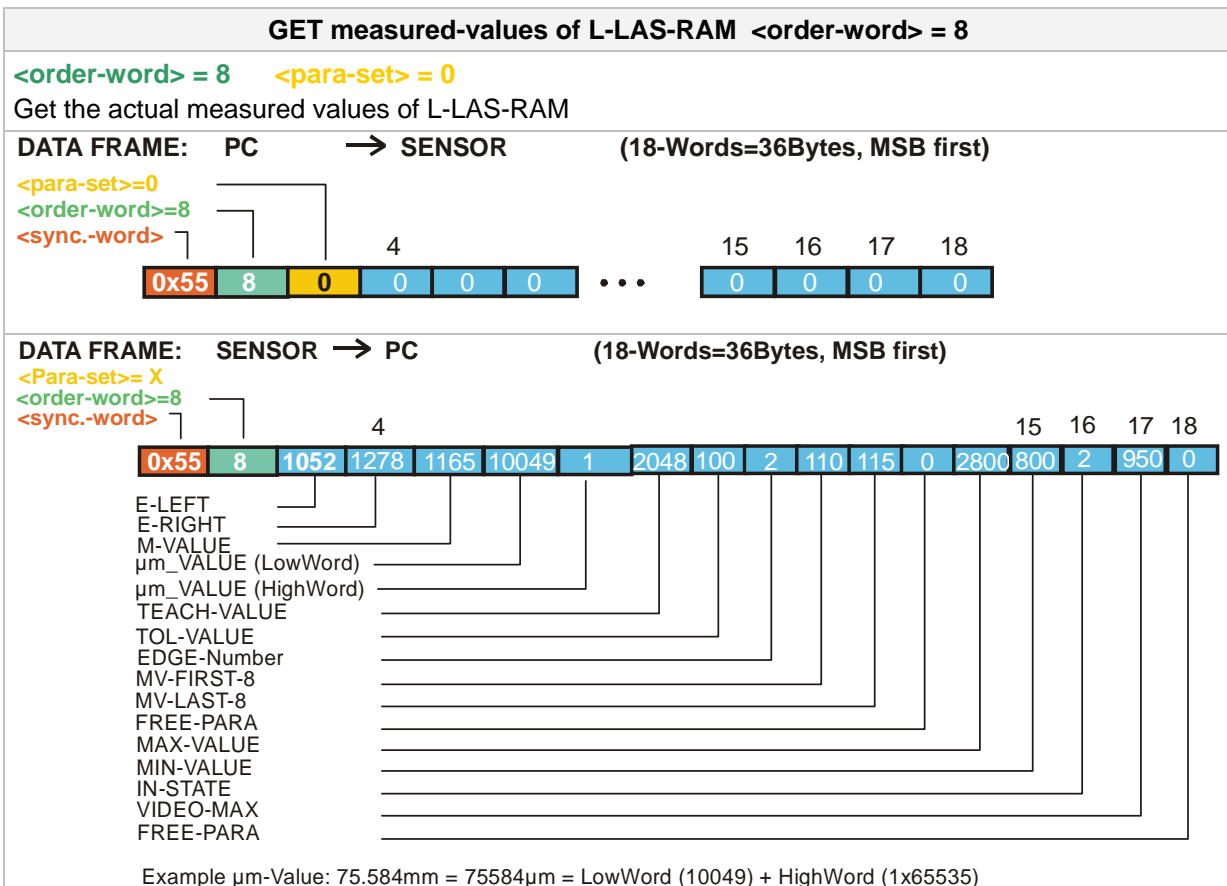
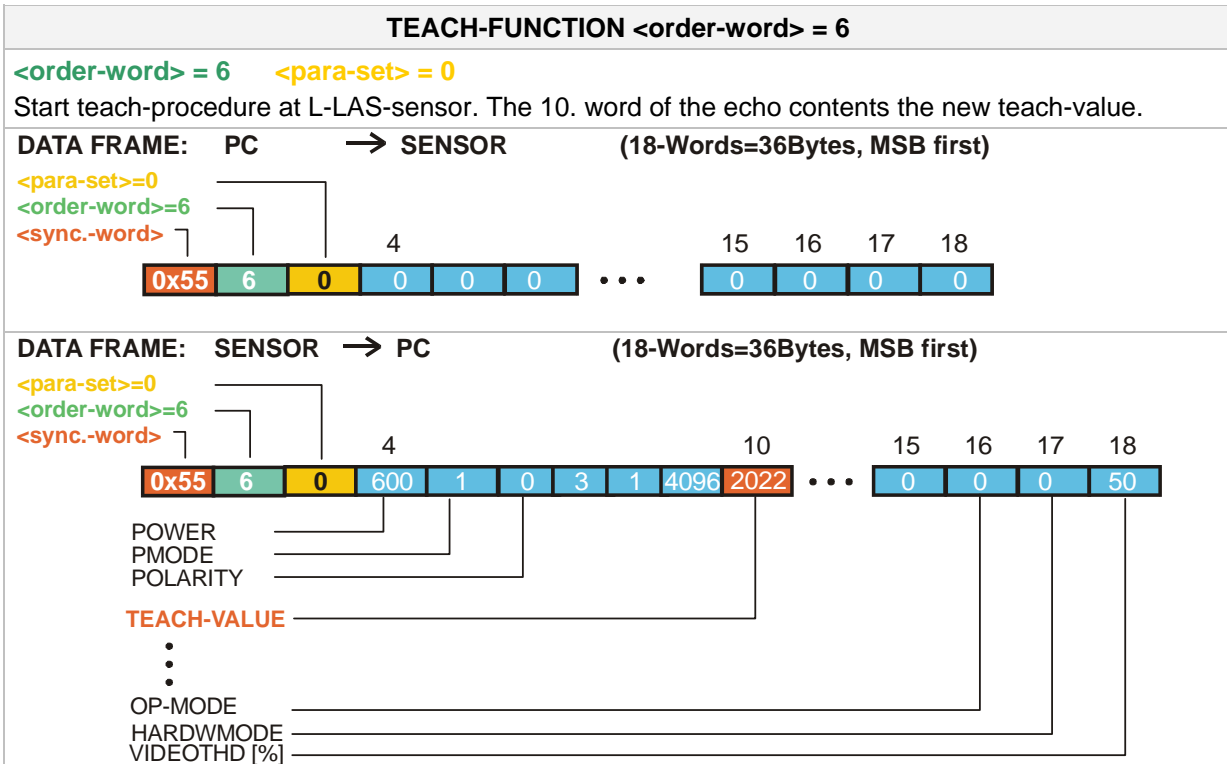

REFRESH-VIDEO-THRESHOLD <order-word> = 13

<order-word> = 13 <para-set> = 0

Start the refresh of the auto-video-threshold at L-LAS-sensor. The new video threshold is calculated from the actual intensity profile over the ccd-line. The parameter VIDEO-THD-AUTO is used for calculation.

ATTENTION: Make sure that the laser-beam is not covered before you start this action!

DATA FRAME: PC → SENSOR (18-Words=36Bytes, MSB first)

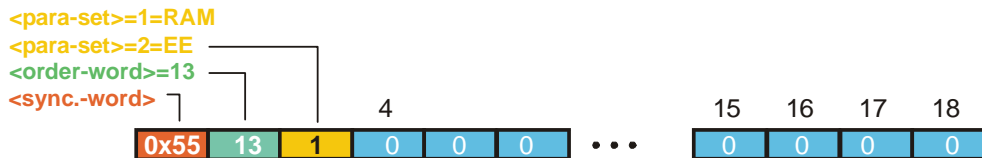

DATA FRAME: SENSOR → PC (18-Words=36Bytes, MSB first)

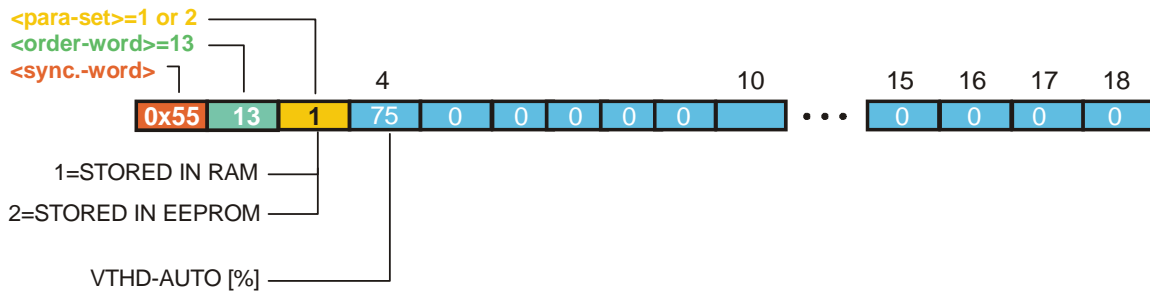

GET measured-values / recorder-of L-LAS-RAM <order-word> = 18

<order-word> = 18 <para-set> = 0

Get the current measurement values of RAM

DATA FRAME: PC → SENSOR (18-Words=36Bytes, MSB first)



DATA FRAME: SENSOR → PC (18-Words=36Bytes, MSB first)

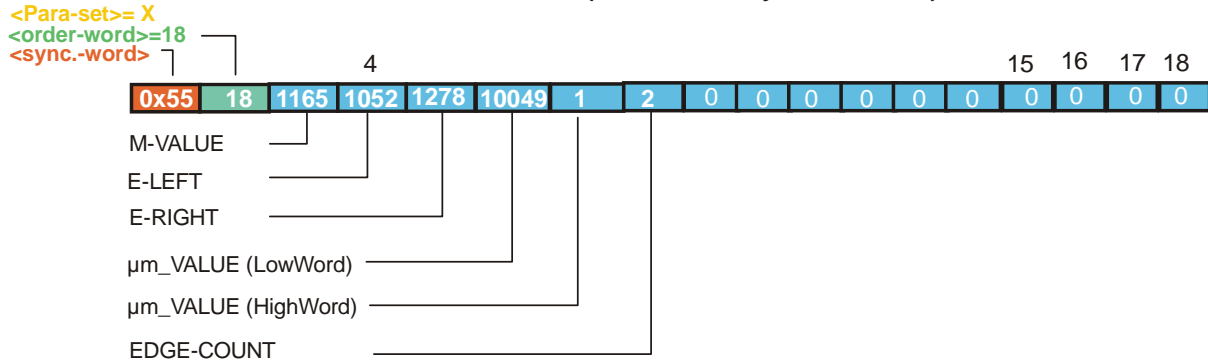

Example µm-Value: 75.584mm = 75584µm = LowWord (10049) + HighWord (1x65535)

Change baudrate: <order-word> = 190

<order-word> = 190

Change rs-232-baudrate at the L-LAS Sensor.

The new baudrate-parameter is transmitted in the 3.rd word <para-set>.

9600 baud = 0, 19200 baud = 1, 38400 baud = 2, 57600 baud = 3, 115200 baud = 4

The transmitted data-frame is automatically echoed back from the L-LAS Sensor by using the old baudrate!!

The new baudrate is stored in the RAM-memory (volatile). To change the baudrate permanently this must be done by the parameter RS-232-BAUD of the second parameter-set=1 by saving the parameter frame to the EEPROM (c.f. order = 3).

DATA FRAME: PC → SENSOR (18-Words=36Bytes, MSB first)

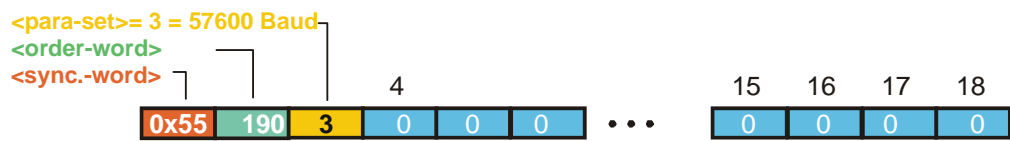

DATA FRAME: SENSOR → PC (18-Words=36Bytes, MSB first)



